

Technical catalog-price list for
«ERGOBOX» products



ERGOBOX[®]

FURNITURE ORGANIZERS



TABLE OF CONTENTS

1. About the company	3
2. General information	4
3. «Classic trays» series (slide length 450 mm)	5
4. «Classic trays» series (slide length 500 mm)	14
5. «Divided trays» series	23
6. «Sliding trays» series	30
7. «Accessories for high drawers» series	31
8. «Boxes» series	42
9. «Wooden boxes» series	45
10. «Additional accessories» series	49
11. Instructions for measuring a furniture box	52

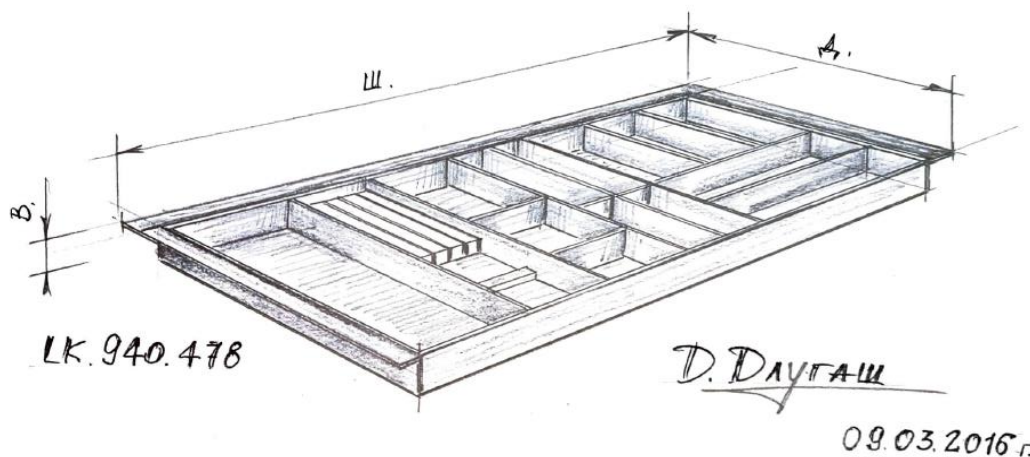

ERGOBOX – Ukrainian manufacturer of accessories for organizing your furniture's interior space. Our goal is to bring comfort and satisfaction to your daily routine.

No more chaos! Everything in its place!

ERGOBOX organizers are useful wherever there are a lot of things. In the kitchen, the wardrobe and dressing room, the nursery and bathroom, the hallway, and even the office.

With **ERGOBOX** accessories, every item has its place. You gain more usable space, save time, and enjoy a great mood because nothing gets lost or misplaced.

Environmentally friendly and made of natural wood, **ERGOBOX** accessories are a unique choice.

Key features of ERGOBOX products:

- natural wood – solid ash;
- treated with a blend of natural plant oils and beeswax;
- customization available to meet individual preferences;
- manufacturer's warranty: 18 months;
- **ERGOBOX** products are proudly made in Ukraine!

Thank you for choosing **ERGOBOX**! We take pleasure in helping you keep your belongings in order.



General information, terms, and definitions used in this technical catalog

1. The Technical catalog – price list has an effective date and remains valid until a new edition is released. The new version of the document supersedes the previous catalog.
2. The manufacturer's warranty is 18 months for all products listed in the Technical catalog.
3. The manufacturing company reserves the right to change the structural features, materials used, and production technology without prior approval from the Consumer. These modifications are made solely to improve product quality and consumer characteristics.

SERIES «CLASSIC TRAYS 450 & 500»



CLASSIC TRAYS are designed to organize space inside low-profile pull-out drawers. They provide a convenient way to store cutlery, kitchen knives, and other kitchen accessories.



Key features of CLASSIC TRAYS:

- frame: solid ash wood, 8 mm thick;
- bottom: MDF coated with ash veneer on both sides, 4 mm thick;
- finish: a blend of natural vegetable oils and beeswax.

TECHNICAL CATALOG-PRICE LIST
series "CLASSIC TRAYS, 450"



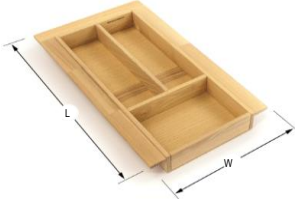



ERGOBOX®

APPEARANCE & DESCRIPTION	CABINET WIDTH, mm	TRAY DIMENSIONS			ARTICLE CODE
		HEIGHT, mm	WIDHT, mm	LENGHT, mm	
<p>BASE TRAY</p> 	300	49	240	428	<p>LKB.240.428 Basic LKB.240.428 Color</p> <p>Tray cutting option</p>
<p>Important!</p> <p>Tray width: min. - 180 mm, max. - 240 mm Tray length: min. - 398 mm, max. - 428 mm <i>(See instructions on page 52)</i></p>					
<p>CLASSIC TRAY</p> 	300	49	240	428	<p>LK.240.428 Basic LK.240.428 Color</p> <p>Tray cutting option</p>
<p>Important!</p> <p>Tray width: min. - 180 mm, max. - 240 mm Tray length: min. - 398 mm, max. - 428 mm <i>(See instructions on page 52)</i></p>					
<p>BASE TRAY</p> 	400	49	340	428	<p>LKB.340.428 Basic LKB.340.428 Color</p> <p>Tray cutting option</p>
<p>THE TRAY INCLUDES ONE (1) SLOTS FOR AN ORGANIZER INSERT</p>	<p>Important!</p> <p>Tray width: min. - 280 mm, max. - 340 mm Tray length: min. - 398 mm, max. - 428 mm <i>(See instructions on page 52)</i></p>				
<p>CLASSIC TRAY</p> 	400	49	340	428	<p>LK.340.428 Basic LK.340.428 Color</p> <p>Tray cutting option</p>
<p>Important!</p> <p>Tray width: min. - 280 mm, max. - 340 mm Tray length: min. - 398 mm, max. - 428 mm <i>(See instructions on page 52)</i></p>					

TECHNICAL CATALOG-PRICE LIST
series "CLASSIC TRAYS, 450"







ERGObOX®

APPEARANCE & DESCRIPTION	CABINET WIDTH, mm	TRAY DIMENSIONS			ARTICLE CODE
		HEIGHT, mm	WIDTH, mm	LENGTH, mm	
<p>BASE TRAY</p>  <p>THE TRAY INCLUDES ONE (1) SLOTS FOR AN ORGANIZER INSERT</p>	450	49	390	428	LKB.390.428 Basic LKB.390.428 Color Tray cutting option
<p>Important!</p> Tray width: min. - 330 mm, max. - 390 mm Tray length: min. - 398 mm, max. - 428 mm <i>(See instructions on page 52)</i>					
<p>CLASSIC TRAY</p> 	450	49	390	428	LK.390.428 Basic LK.390.428 Color Tray cutting option
<p>Important!</p> Tray width: min. - 330 mm, max. - 390 mm Tray length: min. - 398 mm, max. - 428 mm <i>(See instructions on page 52)</i>					
<p>BASE TRAY</p>  <p>THE TRAY INCLUDES TWO (2) SLOTS FOR AN ORGANIZER INSERT</p>	500	49	440	428	LKB.440.428 Basic LKB.440.428 Color Tray cutting option
<p>Important!</p> Tray width: min. - 380 mm, max. - 440 mm Tray length: min. - 398 mm, max. - 428 mm <i>(See instructions on page 52)</i>					
<p>CLASSIC TRAY</p> 	500	49	440	428	LK.440.428 Basic LK.440.428 Color Tray cutting option
<p>Important!</p> Tray width: min. - 380 mm, max. - 440 mm Tray length: min. - 398 mm, max. - 428 mm <i>(See instructions on page 52)</i>					

TECHNICAL CATALOG-PRICE LIST
series "CLASSIC TRAYS, 450"

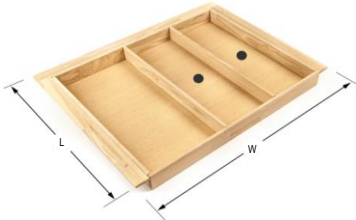





ERGOBOX®

APPEARANCE & DESCRIPTION	CABINET WIDTH, mm	TRAY DIMENSIONS			ARTICLE CODE
		HEIGHT, mm	WIDHT, mm	LENGHT, mm	
<p>BASE TRAY</p>  <p>THE TRAY INCLUDES TWO (2) SLOTS FOR AN ORGANIZER INSERT</p>	600	49	540	428	LKB.540.428 Basic LKB.540.428 Color Tray cutting option
<p>Important! Tray width: min. - 480 mm, max. - 540 mm Tray length: min. - 398 mm, max. - 428 mm <i>(See instructions on page 52)</i></p>					
<p>CLASSIC TRAY</p>  <p>THE TRAY INCLUDES ONE (1) SLOTS FOR AN ORGANIZER INSERT</p>	600	49	540	428	LK.540.428 Basic LK.540.428 Color Tray cutting option
<p>Important! Tray width: min. - 480 mm, max. - 540 mm Tray length: min. - 398 mm, max. - 428 mm <i>(See instructions on page 52)</i></p>					
<p>BASE TRAY</p>  <p>THE TRAY INCLUDES THREE (3) SLOTS FOR AN ORGANIZER INSERT</p>	700	49	640	428	LKB.640.428 Basic LKB.640.428 Color Tray cutting option
<p>Important! Tray width: min. - 580 mm, max. - 640 mm Tray length: min. - 398 mm, max. - 428 mm <i>(See instructions on page 52)</i></p>					
<p>CLASSIC TRAY</p>  <p>THE TRAY INCLUDES ONE (1) SLOTS FOR AN ORGANIZER INSERT</p>	700	49	640	428	LK.640.428 Basic LK.640.428 Color Tray cutting option
<p>Important! Tray width: min. - 580 mm, max. - 640 mm Tray length: min. - 398 mm, max. - 428 mm <i>(See instructions on page 52)</i></p>					

TECHNICAL CATALOG-PRICE LIST
series "CLASSIC TRAYS, 450"

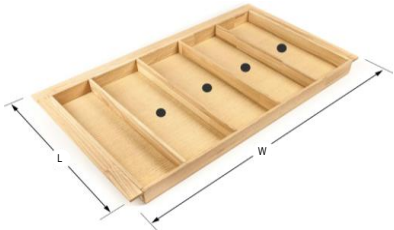

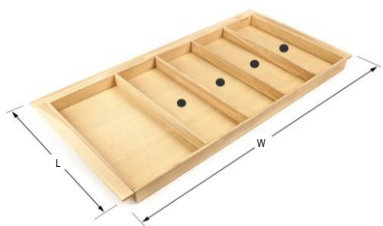



ERGOBOX®

APPEARANCE & DESCRIPTION	CABINET WIDTH, mm	TRAY DIMENSIONS			ARTICLE CODE
		HEIGHT, mm	WIDTH, mm	LENGTH, mm	
<p>BASE TRAY</p>  <p>THE TRAY INCLUDES FOUR (4) SLOTS FOR AN ORGANIZER INSERT</p>	800	49	740	428	LKB.740.428 Basic LKB.740.428 Color Tray cutting option
<p>Important! Tray width: min. - 680 mm, max. - 740 mm Tray length: min. - 398 mm, max. - 428 mm <i>(See instructions on page 52)</i></p>					
<p>CLASSIC TRAY</p>  <p>THE TRAY INCLUDES TWO (2) SLOTS FOR AN ORGANIZER INSERT</p>	800	49	740	428	LK.740.428 Basic LK.740.428 Color Tray cutting option
<p>Important! Tray width: min. - 680 mm, max. - 740 mm Tray length: min. - 398 mm, max. - 428 mm <i>(See instructions on page 52)</i></p>					
<p>BASE TRAY</p>  <p>THE TRAY INCLUDES FOUR (4) SLOTS FOR AN ORGANIZER INSERT</p>	900	49	840	428	LKB.840.428 Basic LKB.840.428 Color Tray cutting option
<p>Important! Tray width: min. - 780 mm, max. - 840 mm Tray length: min. - 398 mm, max. - 428 mm <i>(See instructions on page 52)</i></p>					
<p>CLASSIC TRAY</p>  <p>THE TRAY INCLUDES THREE (3) SLOTS FOR AN ORGANIZER INSERT</p>	900	49	840	428	LK.840.428 Basic LK.840.428 Color Tray cutting option
<p>Important! Tray width: min. - 780 mm, max. - 840 mm Tray length: min. - 398 mm, max. - 428 mm <i>(See instructions on page 52)</i></p>					

TECHNICAL CATALOG-PRICE LIST
series "CLASSIC TRAYS, 450"



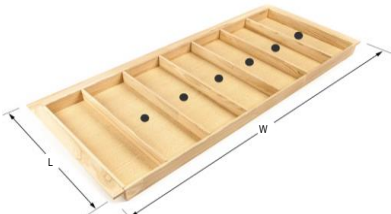

ERGOBOX®

APPEARANCE & DESCRIPTION	CABINET WIDTH, mm	TRAY DIMENSIONS			ARTICLE CODE
		HEIGHT, mm	WIDHT, mm	LENGHT, mm	
<p>BASE TRAY</p>  <p>THE TRAY INCLUDES FIVE (5) SLOTS FOR AN ORGANIZER INSERT</p>	1000	49	940	428	LKB.940.428 Basic LKB.940.428 Color Tray cutting option
<p>Important! Tray width: min. - 880 mm, max. - 940 mm Tray length: min. - 398 mm, max. - 428 mm <i>(See instructions on page 52)</i></p>					
<p>CLASSIC TRAY</p>  <p>THE TRAY INCLUDES THREE (3) SLOTS FOR AN ORGANIZER INSERT</p>	1000	49	940	428	LK.940.428 Basic LK.940.428 Color Tray cutting option
<p>Important! Tray width: min. - 880 mm, max. - 940 mm Tray length: min. - 398 mm, max. - 428 mm <i>(See instructions on page 52)</i></p>					
<p>BASE TRAY</p>  <p>THE TRAY INCLUDES SIX (6) SLOTS FOR AN ORGANIZER INSERT</p>	1100	49	1040	428	LKB.1040.428 Basic LKB.1040.428 Color Tray cutting option
<p>Important! Tray width: min. - 980 mm, max. - 1040 mm Tray length: min. - 398 mm, max. - 428 mm <i>(See instructions on page 52)</i></p>					
<p>CLASSIC TRAY</p>  <p>THE TRAY INCLUDES FOUR (4) SLOTS FOR AN ORGANIZER INSERT</p>	1100	49	1040	428	LK.1040.428 Basic LK.1040.428 Color Tray cutting option
<p>Important! Tray width: min. - 980 mm, max. - 1040 mm Tray length: min. - 398 mm, max. - 428 mm <i>(See instructions on page 52)</i></p>					

TECHNICAL CATALOG-PRICE LIST
series "CLASSIC TRAYS, 450"



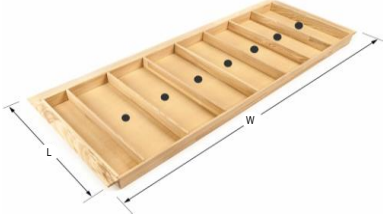

ERGObOX®

APPEARANCE & DESCRIPTION	CABINET WIDTH, mm	TRAY DIMENSIONS			ARTICLE CODE
		HEIGHT, mm	WIDHT, mm	LENGHT, mm	
<p>BASE TRAY</p>  <p>THE TRAY INCLUDES SEVEN (7) SLOTS FOR AN ORGANIZER INSERT</p>	1200	49	1140	428	LKB.1140.428 Basic LKB.1140.428 Color Tray cutting option
<p>Important! Tray width: min. - 1080 mm, max. - 1140 mm Tray length: min. - 398 mm, max. - 428 mm <i>(See instructions on page 52)</i></p>					
<p>CLASSIC TRAY</p>  <p>THE TRAY INCLUDES FIVE (5) SLOTS FOR THE ORGANIZER INSERT</p>	1200	49	1140	428	LK.1140.428 Basic LK.1140.428 Color Tray cutting option
<p>Important! Tray width: min. - 1080 mm, max. - 1140 mm Tray length: min. - 398 mm, max. - 428 mm <i>(See instructions on page 52)</i></p>					

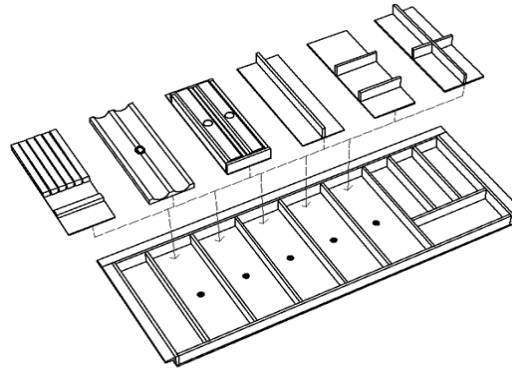
LIST OF ORGANIZER INSERTS FOR "CLASSIC TRAYS, 500"





APPEARANCE & DESCRIPTION	CABINET WIDTH, mm	TRAY DIMENSIONS			ARTICLE CODE
		HEIGHT, mm	WIDHT, mm	LENGHT, mm	
<p>INSERT FOR FIVE (5) KNIVES</p> 	-	24	133	381	VK1.133.381 Basic VK1.133.381 Color
<p>INSERT WITH THREE (3) COMPARTMENTS</p> 	-	44	133	381	VK2.133.381 Basic VK2.133.381 Color
<p>INSERT WITH FOUR (4) COMPARTMENTS</p> 	-	44	133	381	VK3.133.381 Basic VK3.133.381 Color



TECHNICAL CATALOG-PRICE LIST
series "CLASSIC TRAYS, 450"



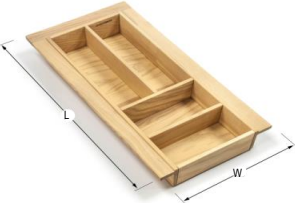

ERGObOX®

APPEARANCE & DESCRIPTION	CABINET WIDTH, mm	TRAY DIMENSIONS			ARTICLE CODE
		HEIGHT, mm	WIDHT, mm	LENGHT, mm	
<p>INSERT FOR ROLL MATERIALS</p> 	-	44	133	381	VK4.133.381 Basic VK4.133.381 Color
<p>INSERT FOR ROLL MATERIALS WITH TEAR-OFF LIDS</p>  <p>INCLUDES REAR COMPENSATOR</p>	-	50	133	381	VK5.133.381 Basic VK5.133.381 Color
<p>INSERT FOR SPICES "STRAIGHT"</p> 	-	20	133	381	VK6.133.381 Basic VK6.133.381 Color

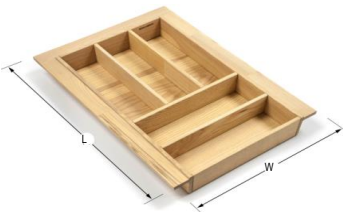

APPEARANCE & DESCRIPTION	CABINET WIDTH, mm	TRAY DIMENSIONS			ARTICLE CODE
		HEIGHT, mm	WIDTH, mm	LENGTH, mm	
<p>BASE TRAY</p> 	300	49	240	478	LKB.240.478 Basic LKB.240.478 Color Tray cutting option
<p>Important!</p> <p>Tray width: min. - 180 mm, max. - 240 mm Tray length: min. - 448 mm, max. - 478 mm <i>(See instructions on page 52)</i></p>					
<p>CLASSIC TRAY</p> 	300	49	240	478	LK.240.478 Basic LK.240.478 Color Tray cutting option
<p>Important!</p> <p>Tray width: min. - 180 mm, max. - 240 mm Tray length: min. - 448 mm, max. - 478 mm <i>(See instructions on page 52)</i></p>					
<p>BASE TRAY</p> 	400	49	340	478	LKB.340.478 Basic LKB.340.478 Color Tray cutting option
<p>THE TRAY INCLUDES ONE (1) SLOTS FOR AN ORGANIZER INSERT</p>	<p>Important!</p> <p>Tray width: min. - 280 mm, max. - 340 mm Tray length: min. - 448 mm, max. - 478 mm <i>(See instructions on page 52)</i></p>				
<p>CLASSIC TRAY</p> 	400	49	340	478	LK.340.478 Basic LK.340.478 Color Tray cutting option
<p>Important!</p> <p>Tray width: min. - 280 mm, max. - 340 mm Tray length: min. - 448 mm, max. - 478 mm <i>(See instructions on page 52)</i></p>					

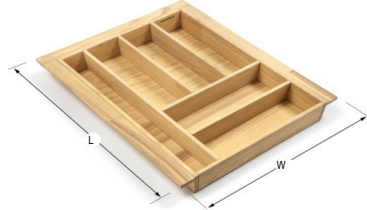
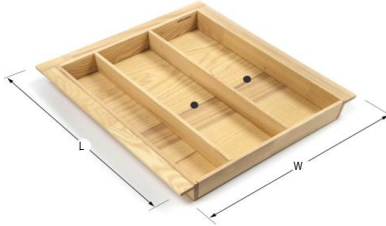

APPEARANCE & DESCRIPTION	CABINET WIDTH, mm	TRAY DIMENSIONS			ARTICLE CODE
		HEIGHT, mm	WIDTH, mm	LENGTH, mm	
<p>BASE TRAY</p> 	450	49	390	478	LKB.390.478 Basic LKB.390.478 Color Tray cutting option
<p>THE TRAY INCLUDES ONE (1) SLOTS FOR AN ORGANIZER INSERT</p>	<p>Important!</p> Tray width: min. - 330 mm, max. - 390 mm Tray length: min. - 448 mm, max. - 478 mm <i>(See instructions on page 52)</i>				
<p>CLASSIC TRAY</p> 	450	49	390	478	LK.390.478 Basic LK.390.478 Color Tray cutting option
<p>THE TRAY INCLUDES ONE (1) SLOTS FOR AN ORGANIZER INSERT</p>	<p>Important!</p> Tray width: min. - 330 mm, max. - 390 mm Tray length: min. - 448 mm, max. - 478 mm <i>(See instructions on page 52)</i>				
<p>BASE TRAY</p> 	500	49	440	478	LKB.440.478 Basic LKB.440.478 Color Tray cutting option
<p>THE TRAY INCLUDES TWO (2) SLOTS FOR AN ORGANIZER INSERT</p>	<p>Important!</p> Tray width: min. - 380 mm, max. - 440 mm Tray length: min. - 448 mm, max. - 478 mm <i>(See instructions on page 52)</i>				
<p>CLASSIC TRAY</p> 	500	49	440	478	LK.440.478 Basic LK.440.478 Color Tray cutting option
<p>THE TRAY INCLUDES TWO (2) SLOTS FOR AN ORGANIZER INSERT</p>	<p>Important!</p> Tray width: min. - 380 mm, max. - 440 mm Tray length: min. - 448 mm, max. - 478 mm <i>(See instructions on page 52)</i>				

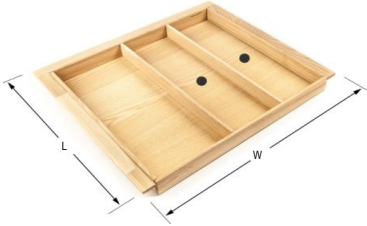
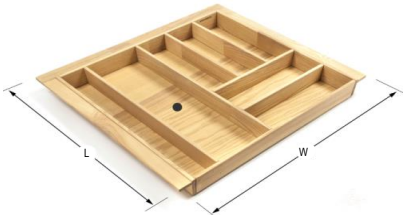
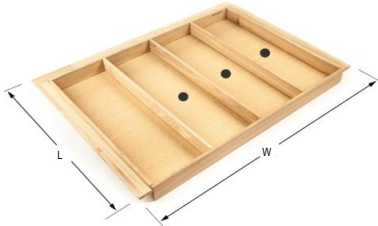
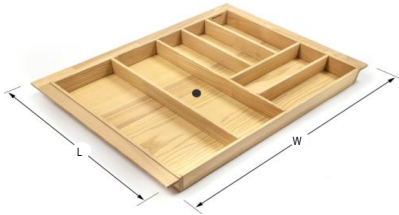

APPEARANCE & DESCRIPTION	CABINET WIDTH, mm	TRAY DIMENSIONS			ARTICLE CODE
		HEIGHT, mm	WIDTH, mm	LENGTH, mm	
<p>BASE TRAY</p>  <p>THE TRAY INCLUDES TWO (2) SLOTS FOR AN ORGANIZER INSERT</p>	600	49	540	478	LKB.540.478 Basic LKB.540.478 Color Tray cutting option
<p>Important! Tray width: min. - 480 mm, max. - 540 mm Tray length: min. - 448 mm, max. - 478 mm <i>(See instructions on page 52)</i></p>					
<p>CLASSIC TRAY</p>  <p>THE TRAY INCLUDES ONE (1) SLOTS FOR AN ORGANIZER INSERT</p>	600	49	540	478	LK.540.478 Basic LK.540.478 Color Tray cutting option
<p>Important! Tray width: min. - 480 mm, max. - 540 mm Tray length: min. - 448 mm, max. - 478 mm <i>(See instructions on page 52)</i></p>					
<p>BASE TRAY</p>  <p>THE TRAY INCLUDES THREE (3) SLOTS FOR AN ORGANIZER INSERT</p>	700	49	640	478	LKB.640.478 Basic LKB.640.478 Color Tray cutting option
<p>Important! Tray width: min. - 580 mm, max. - 640 mm Tray length: min. - 448 mm, max. - 478 mm <i>(See instructions on page 52)</i></p>					
<p>CLASSIC TRAY</p>  <p>THE TRAY INCLUDES ONE (1) SLOTS FOR AN ORGANIZER INSERT</p>	700	49	640	478	LK.640.478 Basic LK.640.478 Color Tray cutting option
<p>Important! Tray width: min. - 580 mm, max. - 640 mm Tray length: min. - 448 mm, max. - 478 mm <i>(See instructions on page 52)</i></p>					

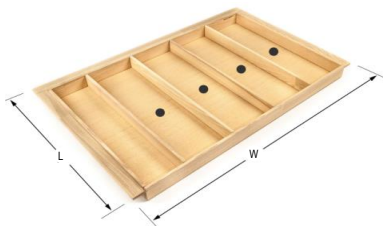
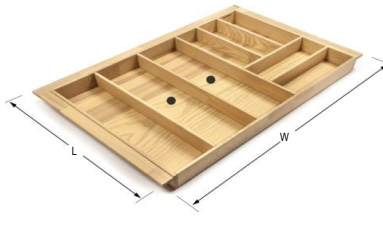
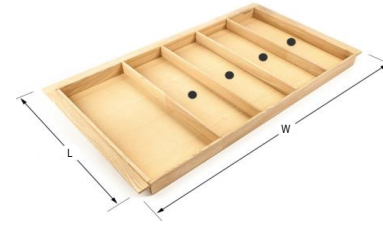
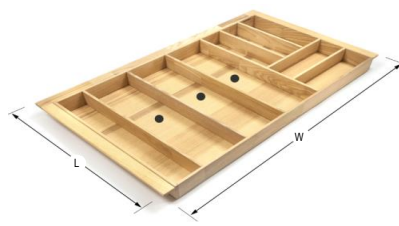
APPEARANCE & DESCRIPTION	CABINET WIDTH, mm	TRAY DIMENSIONS			ARTICLE CODE
		HEIGHT, mm	WIDTH, mm	LENGTH, mm	
<p>BASE TRAY</p>  <p>THE TRAY INCLUDES FOUR (4) SLOTS FOR AN ORGANIZER INSERT</p>	800	49	740	478	LKB.740.478 Basic LKB.740.478 Color Tray cutting option
<p>Important!</p> Tray width: min. - 680 mm, max. - 740 mm Tray length: min. - 448 mm, max. - 478 mm <i>(See instructions on page 52)</i>					
<p>CLASSIC TRAY</p>  <p>THE TRAY INCLUDES TWO (2) SLOTS FOR AN ORGANIZER INSERT</p>	800	49	740	478	LK.740.478 Basic LK.740.478 Color Tray cutting option
<p>Important!</p> Tray width: min. - 680 mm, max. - 740 mm Tray length: min. - 448 mm, max. - 478 mm <i>(See instructions on page 52)</i>					
<p>BASE TRAY</p>  <p>THE TRAY INCLUDES FOUR (4) SLOTS FOR AN ORGANIZER INSERT</p>	900	49	840	478	LKB.840.478 Basic LKB.840.478 Color Tray cutting option
<p>Important!</p> Tray width: min. - 780 mm, max. - 840 mm Tray length: min. - 448 mm, max. - 478 mm <i>(See instructions on page 52)</i>					
<p>CLASSIC TRAY</p>  <p>THE TRAY INCLUDES THREE (3) SLOTS FOR AN ORGANIZER INSERT</p>	900	49	840	478	LK.840.478 Basic LK.840.478 Color Tray cutting option
<p>Important!</p> Tray width: min. - 780 mm, max. - 840 mm Tray length: min. - 448 mm, max. - 478 mm <i>(See instructions on page 52)</i>					

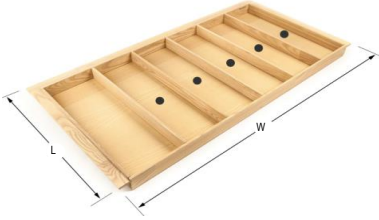
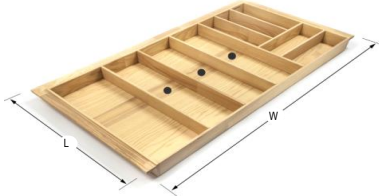
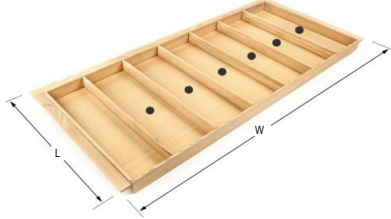
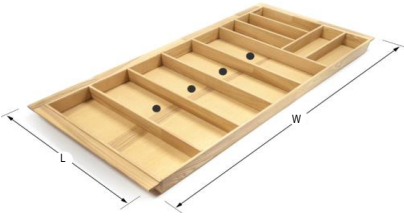

APPEARANCE & DESCRIPTION	CABINET WIDTH, mm	TRAY DIMENSIONS			ARTICLE CODE
		HEIGHT, mm	WIDTH, mm	LENGTH, mm	
<p>BASE TRAY</p>  <p>THE TRAY INCLUDES FIVE (5) SLOTS FOR AN ORGANIZER INSERT</p>	1000	49	940	478	LKB.940.478 Basic LKB.940.478 Color Tray cutting option
<p>Important! Tray width: min. - 880 mm, max. - 940 mm Tray length: min. - 448 mm, max. - 478 mm <i>(See instructions on page 52)</i></p>					
<p>CLASSIC TRAY</p>  <p>THE TRAY INCLUDES THREE (3) SLOTS FOR AN ORGANIZER INSERT</p>	1000	49	940	478	LK.940.478 Basic LK.940.478 Color Tray cutting option
<p>Important! Tray width: min. - 880 mm, max. - 940 mm Tray length: min. - 448 mm, max. - 478 mm <i>(See instructions on page 52)</i></p>					
<p>BASE TRAY</p>  <p>THE TRAY INCLUDES SIX (6) SLOTS FOR AN ORGANIZER INSERT</p>	1100	49	1040	478	LKB.1040.478 Basic LKB.1040.478 Color Tray cutting option
<p>Important! Tray width: min. - 980 mm, max. - 1040 mm Tray length: min. - 448 mm, max. - 478 mm <i>(See instructions on page 52)</i></p>					
<p>CLASSIC TRAY</p>  <p>THE TRAY INCLUDES FOUR (4) SLOTS FOR AN ORGANIZER INSERT</p>	1100	49	1040	478	LK.1040.478 Basic LK.1040.478 Color Tray cutting option
<p>Important! Tray width: min. - 980 mm, max. - 1040 mm Tray length: min. - 448 mm, max. - 478 mm <i>(See instructions on page 52)</i></p>					

TECHNICAL CATALOG-PRICE LIST
series "CLASSIC TRAYS, 500"



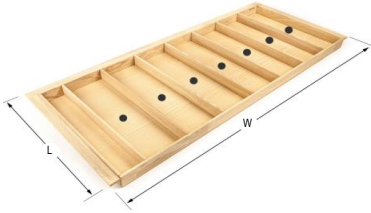
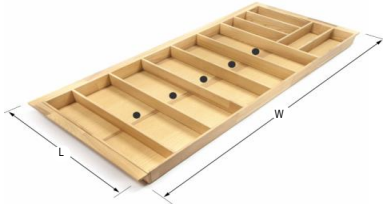

ERGObOX®

APPEARANCE & DESCRIPTION	CABINET WIDTH, mm	TRAY DIMENSIONS			ARTICLE CODE
		HEIGHT, mm	WIDTH, mm	LENGTH, mm	
<p>BASE TRAY</p> 	1200	49	1140	478	LKB.1140.478 Basic LKB.1140.478 Color Tray cutting option
<p>THE TRAY INCLUDES SEVEN (7) SLOTS FOR AN ORGANIZER INSERT</p>	<p>Important! Tray width: min. - 1080 mm, max. - 1140 mm Tray length: min. - 448 mm, max. - 478 mm (See instructions on page 52)</p>				
<p>CLASSIC TRAY</p> 	1200	49	1140	478	LK.1140.478 Basic LK.1140.478 Color Tray cutting option
<p>THE TRAY INCLUDES FIVE (5) SLOTS FOR AN ORGANIZER INSERT</p>	<p>Important! Tray width: min. - 1080 mm, max. - 1140 mm Tray length: min. - 448 mm, max. - 478 mm (See instructions on page 52)</p>				

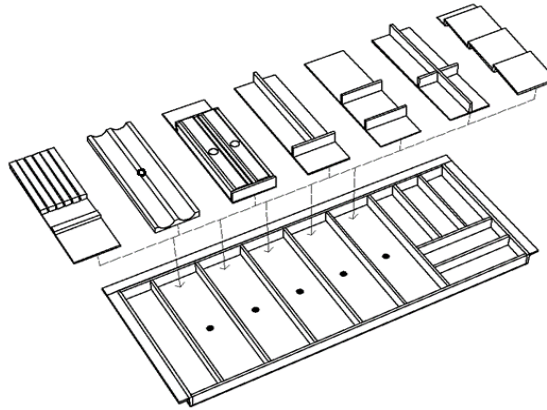
LIST OF ORGANIZER INSERTS FOR "CLASSIC TRAYS, 500"



APPEARANCE & DESCRIPTION	CABINET WIDTH, mm	TRAY DIMENSIONS			ARTICLE CODE
		HEIGHT, mm	WIDTH, mm	LENGTH, mm	
<p>INSERT FOR FIVE (5) KNIVES</p> 	-	24	133	431	VK1.133.431 Basic VK1.133.431 Color
<p>INSERT WITH THREE (3) COMPARTMENTS</p> 	-	44	133	431	VK2.133.431 Basic VK2.133.431 Color
<p>INSERT WITH FOUR (4) COMPARTMENTS</p> 	-	44	133	431	VK3.133.431 Basic VK3.133.431 Color













APPEARANCE & DESCRIPTION	CABINET WIDTH, mm	TRAY DIMENSIONS			ARTICLE CODE
		HEIGHT, mm	WIDTH, mm	LENGTH, mm	
<p>INSERT FOR ROLL MATERIALS</p> 	-	44	133	431	VK4.133.431 Basic VK4.133.431 Color
<p>INSERT FOR ROLL MATERIALS WITH TEAR-OFF LIDS</p>  <p>INCLUDES REAR COMPENSATOR</p>	-	50	133	431	VK5.133.431 Basic VK5.133.431 Color
<p>INSERT FOR SPICES "STRAIGHT"</p> 	-	20	133	431	VK6.133.431 Basic VK6.133.431 Color
<p>INSERT FOR SPICES "ANGLED"</p>  <p>INCLUDES THREE (3) ANGLED PLANES AND A COMPENSATOR</p>	-	24	133	431	VK7.133.431 Basic VK7.133.431 Color

TECHNICAL CATALOG-PRICE LIST
series "CLASSIC TRAYS, 500"



ERGOBOX®

APPEARANCE & DESCRIPTION	CABINET WIDTH, mm	TRAY DIMENSIONS			ARTICLE CODE
		HEIGHT, mm	WIDTH, mm	LENGTH, mm	
<p>CLASSIC ADDITIONAL TRAY</p> 	300	49	240	100	LKD.240.100 Basic LKD.240.100 Color
	300	49	240	150	LKD.240.150 Basic LKD.240.150 Color
	400	49	340	100	LKD.340.100 Basic LKD.340.100 Color
	400	49	340	150	LKD.340.150 Basic LKD.340.150 Color
<p>THE TRAY IS DESIGNED TO FILL THE DRAWER 100% WHEN USED WITH THE CLASSIC TRAY, WITH DRAWER GUIDES RANGING FROM 550 MM TO 650 MM IN LENGTH.</p>	450	49	390	100	LKD.390.100 Basic LKD.390.100 Color
	450	49	390	150	LKD.390.150 Basic LKD.390.150 Color
<p>EXAMPLE OF TRAY PLACEMENT, TOGETHER WITH THE CLASSIC ADDITIONAL TRAY.</p> 	500	49	440	100	LKD.440.100 Basic LKD.440.100 Color
	500	49	440	150	LKD.440.150 Basic LKD.440.150 Color
	600	49	540	100	LKD.540.100 Basic LKD.540.100 Color
	600	49	540	150	LKD.540.150 Basic LKD.540.150 Color
	700	49	640	100	LKD.640.100 Basic LKD.640.100 Color
	700	49	640	150	LKD.640.150 Basic LKD.640.150 Color
	800	49	740	100	LKD.740.100 Basic LKD.740.100 Color
	800	49	740	150	LKD.740.150 Basic LKD.740.150 Color
	900	49	840	100	LKD.840.100 Basic LKD.840.100 Color
	900	49	840	150	LKD.840.150 Basic LKD.840.150 Color
	1000	49	940	100	LKD.940.100 Basic LKD.940.100 Color
	1000	49	940	150	LKD.940.150 Basic LKD.940.150 Color
	1100	49	1040	100	LKD.1040.100 Basic LKD.1040.100 Color
	1100	49	1040	150	LKD.1040.150 Basic LKD.1040.150 Color
	1200	49	1140	100	LKD.1140.100 Basic LKD.1140.100 Color
	1200	49	1140	150	LKD.1140.150 Basic LKD.1140.150 Color
<p>Important! The classic additional tray is selected by width to match the size of the corresponding Classic tray.</p>					

SERIES "DIVIDED TRAYS"



DIVIDED TRAYS are designed to organize the internal space of low pull-out drawers. The trays are convenient for placing tableware, knives, and other kitchen items.

DIVIDED TRAYS are selected in the required size and quantity to fit the drawer.

ADVANTAGES! The consumer can organize the drawer space according to their own needs.



Key features of DIVIDED TRAYS:

- frame: ash wood, thickness 8 mm;
- bottom: MDF, covered with ash veneer on both sides, thickness 4 mm;
- finish: a blend of natural plant oils and beeswax.

The manufacturing company reserves the right to change the structural features, materials used, and production technology without prior approval from the Consumer. These modifications are made solely to improve product quality and consumer characteristics.





TECHNICAL CATALOG-PRICE LIST
SERIES "DIVIDED TRAYS"



APPEARANCE & DESCRIPTION	CABINET WIDTH, mm	TRAY DIMENSIONS			ARTICLE CODE
		HEIGHT, mm	WIDHT, mm	LENGHT, mm	
<p>MULTIFUNCTIONAL TRAY</p> 	-	49	150	480	LR.150.480 Basic LR.150.480 Color Tray cutting option
<p>NOTE! This tray is compatible with organizer inserts, article code, ARTICLE CODE VKx.133.393</p>					
<p>UNIVERSAL TRAY</p> 	-	49	150	480	LR1.150.480 Basic LR1.150.480 Color
	-	49	200	480	LR1.200.480 Basic LR1.200.480 Color Tray cutting option
<p>TRAY FOR CUTLERY</p> 	-	49	250	480	LR2.250.480 Basic LR2.250.480 Color Tray cutting option
<p>TRAY FOR CUTLERY</p> 	-	49	250	480	LR3.250.480 Basic LR3.250.480 Color Tray cutting option

TECHNICAL CATALOG-PRICE LIST
SERIES "DIVIDED TRAYS"





APPEARANCE & DESCRIPTION	CABINET WIDTH, mm	TRAY DIMENSIONS			ARTICLE CODE
		HEIGHT, mm	WIDHT, mm	LENGHT, mm	
<p>INSERT FOR FIVE (5) KNIVES</p> 	-	24	133	393	VK1.133.393 Basic VK1.133.393 Color
<p>INSERT WITH THREE (3) COMPARTMENTS</p> 	-	44	133	393	VK2.133.393 Basic VK2.133.393 Color
<p>INSERT WITH FOUR (4) COMPARTMENTS</p> 	-	44	133	393	VK3.133.393 Basic VK3.133.393 Color
<p>INSERT FOR ROLL MATERIALS</p> 	-	44	133	393	VK4.133.393 Basic VK4.133.393 Color

TECHNICAL CATALOG-PRICE LIST
SERIES "DIVIDED TRAYS"

APPEARANCE & DESCRIPTION	CABINET WIDTH, mm	TRAY DIMENSIONS			ARTICLE CODE
		HEIGHT, mm	WIDHT, mm	LENGHT, mm	
<p>INSERT FOR ROLL MATERIALS WITH TEAR-OFF LIDS</p>  <p>(В КОМПЛЕКТІ ЗАДНІЙ КОМПЕНСАТОР)</p>	-	50	133	393	VK5.133.393 Basic VK5.133.393 Color
<p>INCLUDES REAR COMPENSATOR</p> 	-	20	133	393	VK6.133.393 Basic VK6.133.393 Color
<p>INSERT FOR SPICES "STRAIGHT"</p>  <p>INCLUDES THREE (3) ANGLED PLANES</p>	-	24	133	393	VK7.133.393 Basic VK7.133.393 Color
<p>ADDITIONAL DIVIDED TRAY</p>  <p>FOR DRAWERS LONGER THAN 480 MM</p>	300 - 600	49	540	100	LRD.540.100 Basic LRD.540.100 Color
	300 - 600	49	540	150	LRD.540.150 Basic LRD.540.150 Color
	<p>NOTE! THE ADDITIONAL DIVIDED TRAY IS PLACED ALONG THE FRONT OR REAR WALL OF THE DRAWER.</p>				

TECHNICAL CATALOG-PRICE LIST
SERIES "DIVIDED TRAYS"

APPEARANCE & DESCRIPTION	CABINET WIDTH, mm	TRAY DIMENSIONS			ARTICLE CODE
		HEIGHT, mm	WIDTH, mm	LENGTH, mm	
ADDITIONAL DIVIDED TRAY FOR DRAWERS 	650 - 900	49	840	100	LRD.840.100 Basic LRD.840.100 Color
	650 - 900	49	840	150	LRD.840.150 Basic LRD.840.150 Color
LONGER THAN 480 MM	NOTE! THE ADDITIONAL DIVIDED TRAY IS PLACED ALONG THE FRONT OR REAR WALL OF THE DRAWER.				
ADDITIONAL DIVIDED TRAY FOR DRAWERS 	950 - 1200	49	1140	100	LRD.1140.100 Basic LRD.1140.100 Color
	950 - 1200	49	1140	150	LRD.1140.150 Basic LRD.1140.150 Color
LONGER THAN 480 MM	NOTE! THE ADDITIONAL DIVIDED TRAY IS PLACED ALONG THE FRONT OR REAR WALL OF THE DRAWER.				

EXAMPLE OF TRAY PLACEMENT,
 TOGETHER WITH THE ADDITIONAL DIVIDED TRAY

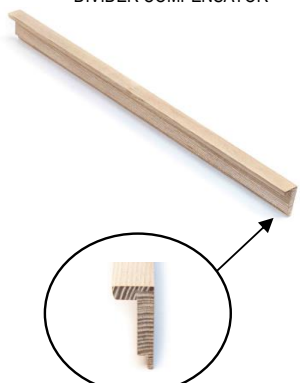

TECHNICAL CATALOG-PRICE LIST
SERIES "DIVIDED TRAYS"

APPEARANCE & DESCRIPTION	CABINET WIDTH, mm	TRAY DIMENSIONS			ARTICLE CODE
		HEIGHT, mm	WIDHT, mm	LENGHT, mm	
 <p>DIVIDER COMPENSATOR</p>	-	47	20	480	KR.20.480 Basic KR.20.480 Color
	-	47	20	530	KR.20.530 Basic KR.20.530 Color
	-	47	20	580	KR.20.580 Basic KR.20.580 Color
	-	47	20	630	KR.20.630 Basic KR.20.630 Color

EXAMPLE OF TRAY PLACEMENT,
 TOGETHER WITH THE DIVIDER COMPENSATOR



Tip!
 Before placing the trays and compensators in the drawer
 we recommend lining the bottom of the drawer
 with a rubber mat and leaving some free space between the trays.

INSTRUCTIONS FOR INSTALLATION OF "DIVIDED TRAYS"

Option A. USE OF DIVIDER COMPENSATORS. SUITABLE FOR ALL TYPES OF DRAWERS.
THE BOTTOM OF THE DRAWER IS LINED WITH A RUBBER MAT:

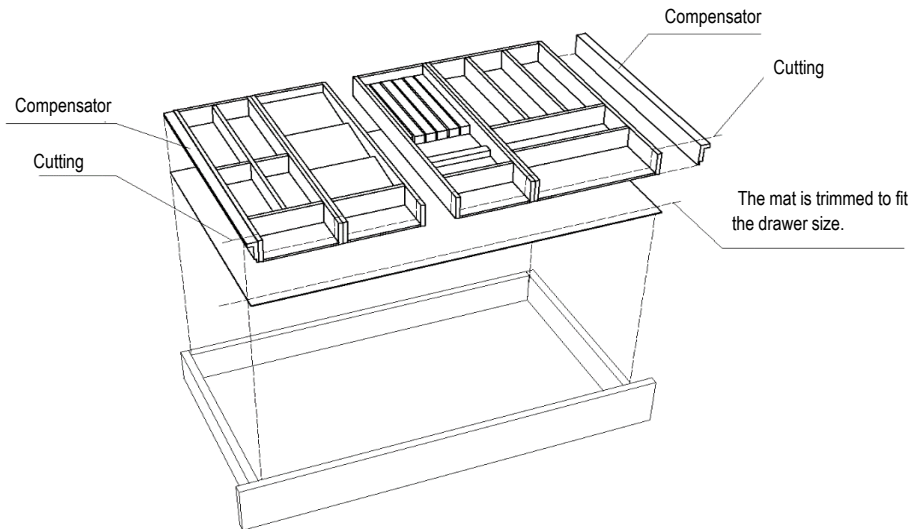

Option B. IF THE DRAWER HAS FLAT SIDES, SIDE COMPENSATORS ARE USED:

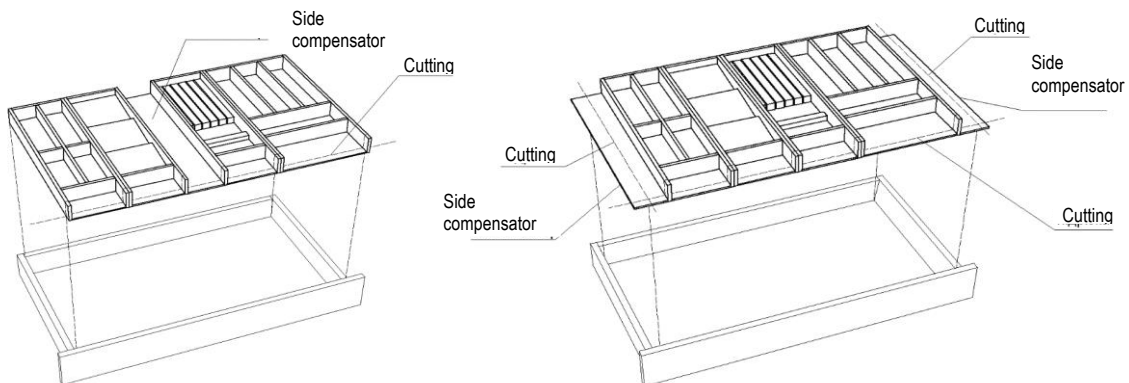

1. THE WIDTH OF THE TRAY SET IS FORMED BY ADDING THEM TO EACH OTHER.
TO FILL THE DRAWER 100%, THE SIDE COMPENSATOR IS TRIMMED TO FIT THE REMAINING SPACE,
OR THE DRAWER IS FIRST LINED WITH A RUBBER MAT ON WHICH THE SELECTED TRAYS ARE PLACED.
2. THE TRAYS HAVE MAXIMUM LENGTH FOR DRAWERS WITH A 500 mm EXTENSION.
THE LENGTH OF THE TRAYS IS ADJUSTED ON THE FRONT SIDE BY TRIMMING.
3. AFTER TRIMMING THE TRAY, TREAT THE TRIMMING AREA WITH A MIXTURE OF OIL AND WAX (NOT INCLUDED IN THE SET).

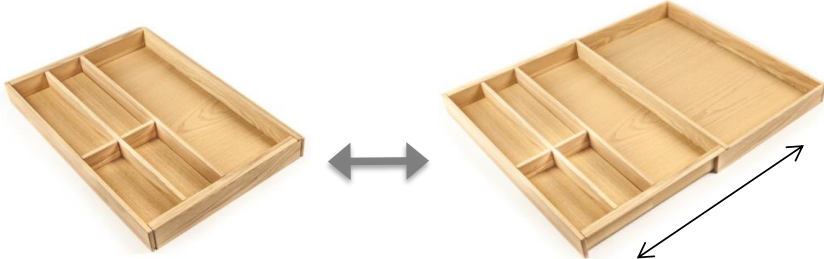
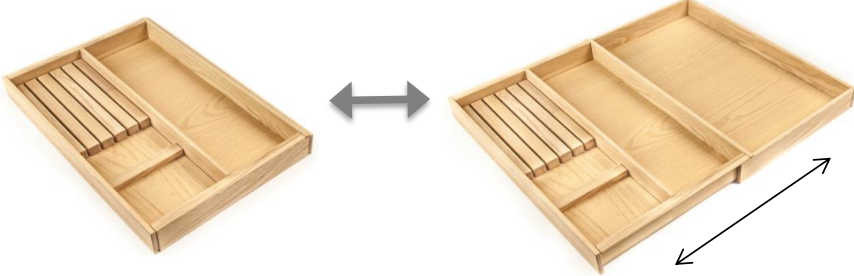
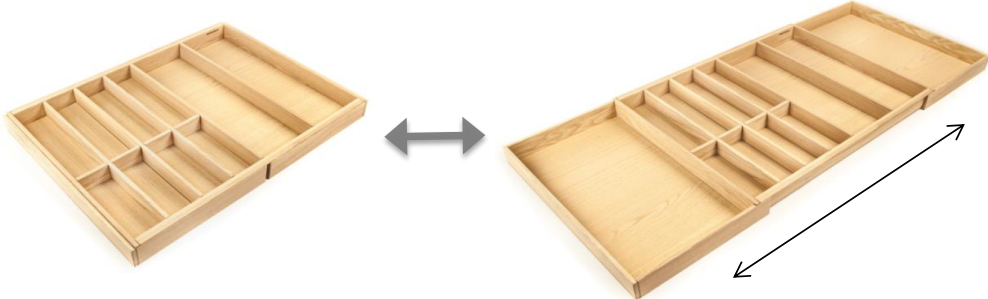
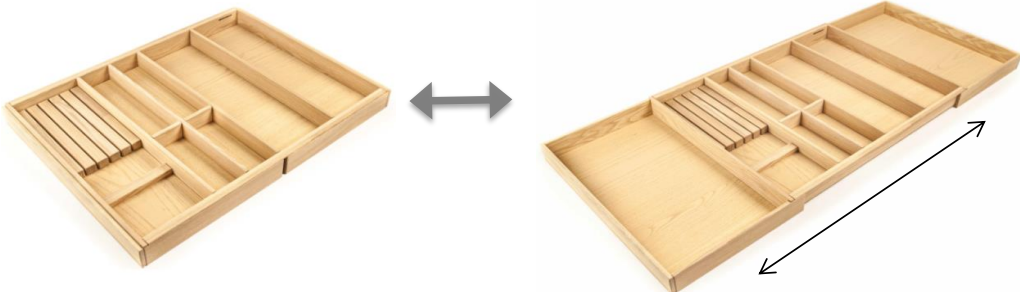

Universal tray, suitable for any type of drawer, with a rail length of 500 mm or more
(trays are made only in Natural color!).

APPEARANCE & DESCRIPTION	CABINET WIDTH, mm	ORGANISER SIZE			ARTICLE CODE
		HEIGHT, mm	WIDHT, mm	LENGHT, mm	
<p>SLIDING TRAY FOR CUTLERY</p> 	-	54	300 - 570	450	LR-P.300.450
<p>SLIDING TRAY FOR KNIVES AND CUTLERY</p> 	-	54	300 - 570	450	LR-N.300.450
<p>SLIDING TRAY FOR CUTLERY</p> 	-	54	592 - 1120	450	LR-PP.592.450
<p>SLIDING TRAY FOR KNIVES AND CUTLERY</p> 	-	54	592 - 1120	450	LR-PN.592.450

series "ACCESSORIES FOR HIGH DRAWERS"





TECHNICAL CATALOG-PRICE
series "ACCESSORIES FOR HIGH DRAWERS"

APPEARANCE & DESCRIPTION	CABINET WIDTH, mm	ORGANISER SIZE			ARTICLE CODE
		HEIGHT, mm	WIDHT, mm	LENGHT, mm	
<p>PERFORATED BOTTOM</p> 	500	12	440	480	DP.440.480 Basic DP.440.480 Color
	600	12	540	480	DP.540.480 Basic DP.540.480 Color
	700	12	640	480	DP.640.480 Basic DP.640.480 Color
	800	12	740	480	DP.740.480 Basic DP.740.480 Color
	900	12	840	480	DP.840.480 Basic DP.840.480 Color
	1000	12	940	480	DP.940.480 Basic DP.940.480 Color
	1100	12	1040	480	DP.1040.480 Basic DP.1040.480 Color
	MDF 7 mm, ash veneer on both sides, legs included	1200	12	1140	480
<p>PLATE ORGANIZER</p> 		180	-	-	OT.40.180 Basic OT.40.180 Color
<p>Set of 4 (four) columns + screws for fixation (perforated bottom not included in the set)</p>	<p>Note! The minimum height inside the drawer is 200 mm</p>				
<p>"COMB" PLATE ORGANIZER</p> 	min 450	130	-	444	OT.130.444 Basic OT.130.444 Color
<p>Set of 2 (two) parts + screws for fixation (perforated bottom not included in the set)</p>	<p>Note! The minimum height inside the drawer is 200 mm FOR DRAWERS WITH SLIDES 500 mm AND MORE</p>				



TECHNICAL CATALOG-PRICE
series "ACCESSORIES FOR HIGH DRAWERS"

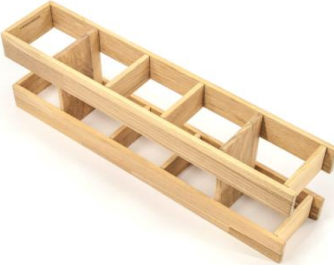

APPEARANCE & DESCRIPTION	CABINET WIDTH, mm	ORGANISER SIZE			ARTICLE CODE
		HEIGHT, mm	WIDHT, mm	LENGHT, mm	
<p>ORGANIZER FOR 4 BOTTLES</p>  <p>Set of 2 (two) parts + screws for fixation, recommended width between organizers 256 mm (perforated bottom is not included in the set)</p>	min 500	65	-	452	OB 4.65.452 Basic OB 4.65.452 Color
<p>Note! The minimum height inside the drawer is 150 mm FOR DRAWERS WITH SLIDES 500 mm AND MORE</p>					
<p>ORGANIZER FOR 8 BOTTLES</p>  <p>Set of 2 (two) parts + screws for fixation, recommended width between organizers 256 mm (perforated bottom is not included in the set)</p>	min 500	159	-	452	OB 8.159.452 Basic OB 8.159.452 Color
<p>Note! The minimum height inside the drawer is 220 mm FOR DRAWERS WITH SLIDES 500 mm AND MORE</p>					
<p>BOTTLE ORGANIZER (vertical bottle storage)</p> 	-	159	100	480	OB 5.100.159.480 Basic OB 5.100.159.480 Color Organizer cutting option
<p>Note! The minimum height inside the drawer is 300 mm</p>					

TECHNICAL CATALOG-PRICE
series "ACCESSORIES FOR HIGH DRAWERS"



APPEARANCE & DESCRIPTION	CABINET WIDTH, mm	ORGANISER SIZE			ARTICLE CODE
		HEIGHT, mm	WIDHT, mm	LENGHT, mm	
<p>FRYING PAN ORGANIZER</p> 	-	159	-	196	OS.159.196 Basic OS.159.196 Color
<p>Set of 3 (three) dividers + screws for fixation (perforated bottom is not included in the set)</p>	<p>Note! The minimum height inside the drawer is 300 mm</p>				
<p>ORGANIZER FOR 3 (three) BOTTLES</p> 	min 300	48	150	480	OB 3.150.480 Basic OB 3.150.480 Color Organizer cutting option
<p>For a bottle with a diameter of 112 mm</p>	<p>Note! Min. height inside the drawer is 150 mm for bottles with a height of 120 mm (700 ml) Min. height inside the drawer is 200 mm for bottles with a height of 170 mm (1200 ml) Min. height inside the drawer is 250 mm for bottles with a height of 220 mm (1500 ml) Min. height inside the drawer is 300 mm for bottles with a height of 270 mm (1800 ml)</p> <p>FOR DRAWERS WITH SLIDES 500 mm AND MORE</p>				
<p>ORGANIZER FOR 6 (six) BOTTLES</p> 	min 450	48	300	480	OB 6.300.480 Basic OB 6.300.480 Color Organizer cutting option
<p>For bottles with a diameter of 112 mm</p>	<p>Note! Min. height inside the drawer is 150 mm for bottles with a height of 120 mm (700 ml) Min. height inside the drawer is 200 mm for bottles with a height of 170 mm (1200 ml) Min. height inside the drawer is 250 mm for bottles with a height of 220 mm (1500 ml) Min. height inside the drawer is 300 mm for bottles with a height of 270 mm (1800 ml)</p> <p>FOR DRAWERS WITH SLIDES 500 mm AND MORE</p>				



TECHNICAL CATALOG-PRICE
series "ACCESSORIES FOR HIGH DRAWERS"

APPEARANCE & DESCRIPTION	CABINET WIDTH, mm	ORGANISER SIZE			ARTICLE CODE
		HEIGHT, mm	WIDHT, mm	LENGHT, mm	
<p>DIVIDER ORGANIZER, 5 SECTIONS</p> 	-	107	150	480	OR 5.107.150.480 Basic OR 5.107.150.480 Color
	-	107	200	480	OR 5.107.200.480 Basic OR 5.107.200.480 Color
	-	107	250	480	OR 5.107.250.480 Basic OR 5.107.250.480 Color Organizer cutting option
<p>DIVIDER ORGANIZER, 4 SECTIONS</p> 	-	107	150	480	OR 4.107.150.480 Basic OR 4.107.150.480 Color
	-	107	200	480	OR 4.107.200.480 Basic OR 4.107.200.480 Color
	-	107	250	480	OR 4.107.250.480 Basic OR 4.107.250.480 Color Organizer cutting option
<p>DIVIDER ORGANIZER, 3 SECTIONS</p> 	-	107	150	480	OR 3.107.150.480 Basic OR 3.107.150.480 Color
	-	107	200	480	OR 3.107.200.480 Basic OR 3.107.200.480 Color
	-	107	250	480	OR 3.107.250.480 Basic OR 3.107.250.480 Color Organizer cutting option



TECHNICAL CATALOG-PRICE
series "ACCESSORIES FOR HIGH DRAWERS"

APPEARANCE & DESCRIPTION	CABINET WIDTH, mm	ORGANISER SIZE			ARTICLE CODE
		HEIGHT, mm	WIDHT, mm	LENGHT, mm	
<p>DIVIDER ORGANIZER, 5 SECTIONS</p> 	-	159	150	480	OR 5.159.150.480 Basic OR 5.159.150.480 Color
	-	159	200	480	OR 5.159.200.480 Basic OR 5.159.200.480 Color
	-	159	250	480	OR 5.159.250.480 Basic OR 5.159.250.480 Color Organizer cutting option
<p>DIVIDER ORGANIZER, 4 SECTIONS</p> 	-	159	150	480	OR 4.159.150.480 Basic OR 4.159.150.480 Color
	-	159	200	480	OR 4.159.200.480 Basic OR 4.159.200.480 Color
	-	159	250	480	OR 4.159.250.480 Basic OR 4.159.250.480 Color Organizer cutting option
<p>DIVIDER ORGANIZER, 3 SECTIONS</p> 	-	159	150	480	OR 3.159.150.480 Basic OR 3.159.150.480 Color
	-	159	200	480	OR 3.159.200.480 Basic OR 3.159.200.480 Color
	-	159	250	480	OR 3.159.250.480 Basic OR 3.159.250.480 Color Organizer cutting option

TECHNICAL CATALOG-PRICE LIST
series "ACCESSORIES FOR HIGH DRAWERS"

APPEARANCE & DESCRIPTION	CABINET WIDTH, mm	ORGANISER SIZE			ARTICLE CODE
		HEIGHT, mm	WIDHT, mm	LENGHT, mm	
<p>LID ORGANIZER</p>  <p>It is recommended to use together with a mat covering the entire bottom of the drawer.</p>	600	159	540	120	OK.540.120 Basic OK.540.120 Color
	900	159	840	120	OK.840.120 Basic OK.840.120 Color
	1200	159	1140	120	OK.1140.120 Basic OK.1140.120 Color Organizer cutting option
<p>LID ORGANIZER</p> 	-	107	300	480	OK.300.480 Basic OK.300.480 Color Organizer cutting option
<p>BREAD BOX WITH SLIDING LID</p>  <p>It is recommended to use with a rear divider.</p>	-	211	250	400	HD.250.400 Basic HD.250.400 Color
	<p>Note! The lid serves as a cutting board, made only in NATURAL color and treated with olive oil.</p>				

TECHNICAL CATALOG-PRICE LIST
series "ACCESSORIES FOR HIGH DRAWERS"

APPEARANCE & DESCRIPTION	CABINET WIDTH, mm	ORGANISER SIZE			ARTICLE CODE												
		HEIGHT, mm	WIDHT, mm	LENGHT, mm													
<p>BREAD BOX WITH SLIDING LID</p>  <p>It is recommended to use with a rear divider.</p>	-	211	250	400	<p>HR.250.400 Basic HR.250.400 Color</p>												
<p>Note! The height of the rear wall of the drawer should not exceed 180 mm.</p>																	
<p>CUTTING BOARD STORAGE ORGANIZER</p> 	-	-	100	480	<p>OD.100.480 Basic OD.100.480 Color</p> <p>Organizer cutting option</p>												
<p>CUTTING BOARDS (3 pcs.)</p> 					<p>KD.304.369.434</p>												
<p>Board dimensions:</p> <table border="1"> <tr> <td>14</td> <td>200</td> <td>304</td> <td>D.304</td> </tr> <tr> <td>14</td> <td>200</td> <td>369</td> <td>D.369</td> </tr> <tr> <td>14</td> <td>200</td> <td>434</td> <td>D.434</td> </tr> </table>						14	200	304	D.304	14	200	369	D.369	14	200	434	D.434
14	200	304	D.304														
14	200	369	D.369														
14	200	434	D.434														
<p>Note! The cutting boards are made only in NATURAL color.</p>																	

TECHNICAL CATALOG-PRICE LIST
series "ACCESSORIES FOR HIGH DRAWERS"

APPEARANCE & DESCRIPTION	CABINET WIDTH, mm	ORGANISER SIZE			ARTICLE CODE
		HEIGHT, mm	WIDHT, mm	LENGHT, mm	
<p>UNIVERSAL ORGANIZER</p>  <p>Includes screws for fixation (perforated bottom is not included in the set).</p>	-	130	-	132	OU.130.132 Basic OU.130.132 Color
	-	130	-	196	OU.130.196 Basic OU.130.196 Color
	-	130	-	452	OU.130.452 Basic OU.130.452 Color

INSTALLATION INSTRUCTIONS FOR HIGH CABINET ACCESSORIES

1. THE PERFORATED BOTTOM IS TRIMMED SYMMETRICALLY ON ALL 4 SIDES TO FIT THE SIZE OF THE CABINET'S BOTTOM

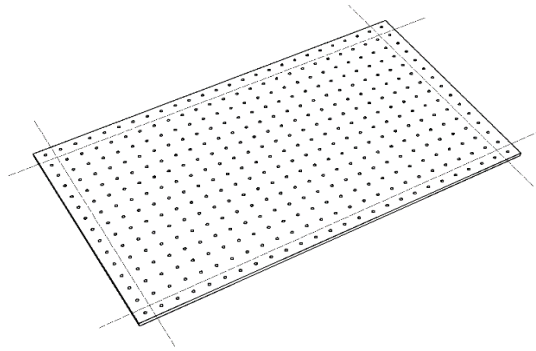

THE SET INCLUDES LEGS
THAT ARE ATTACHED TO THE BACK SIDE
OF THE PERFORATED BOTTOM.

2. ALL ORGANIZERS ARE FIXED TO THE PERFORATED BOTTOM WITH SCREWS.

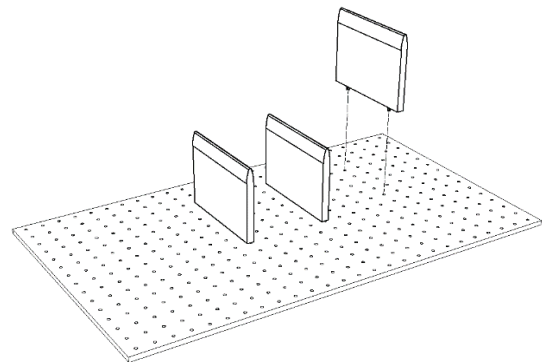
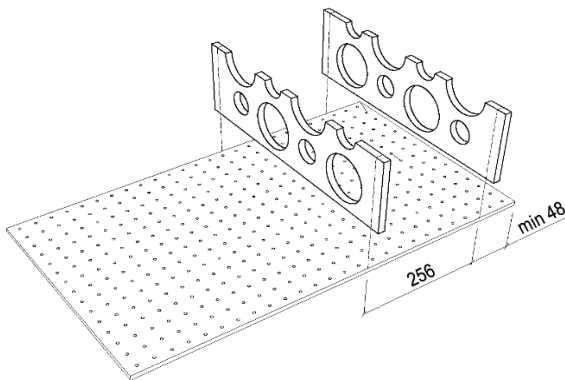

3. LID ORGANIZERS ARE TRIMMED TO THE CABINET'S SIZE IN BOTH LENGTH AND WIDTH.

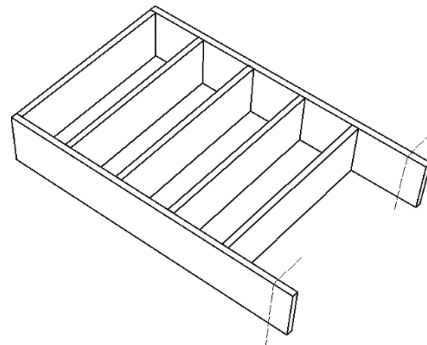
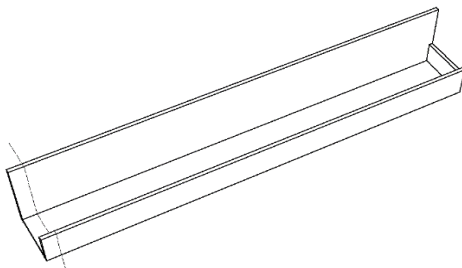

4. BOTTLE ORGANIZERS ARE TRIMMED IN LENGTH FROM THE BACK SIDE.

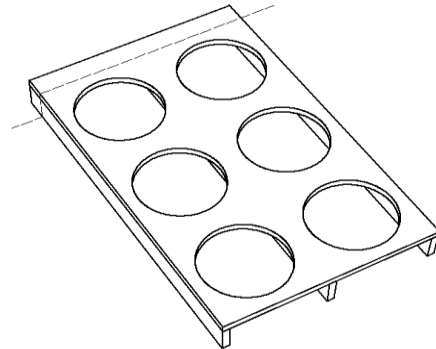

5. INSTRUCTIONS FOR INSTALLING DIVIDER ORGANIZERS.

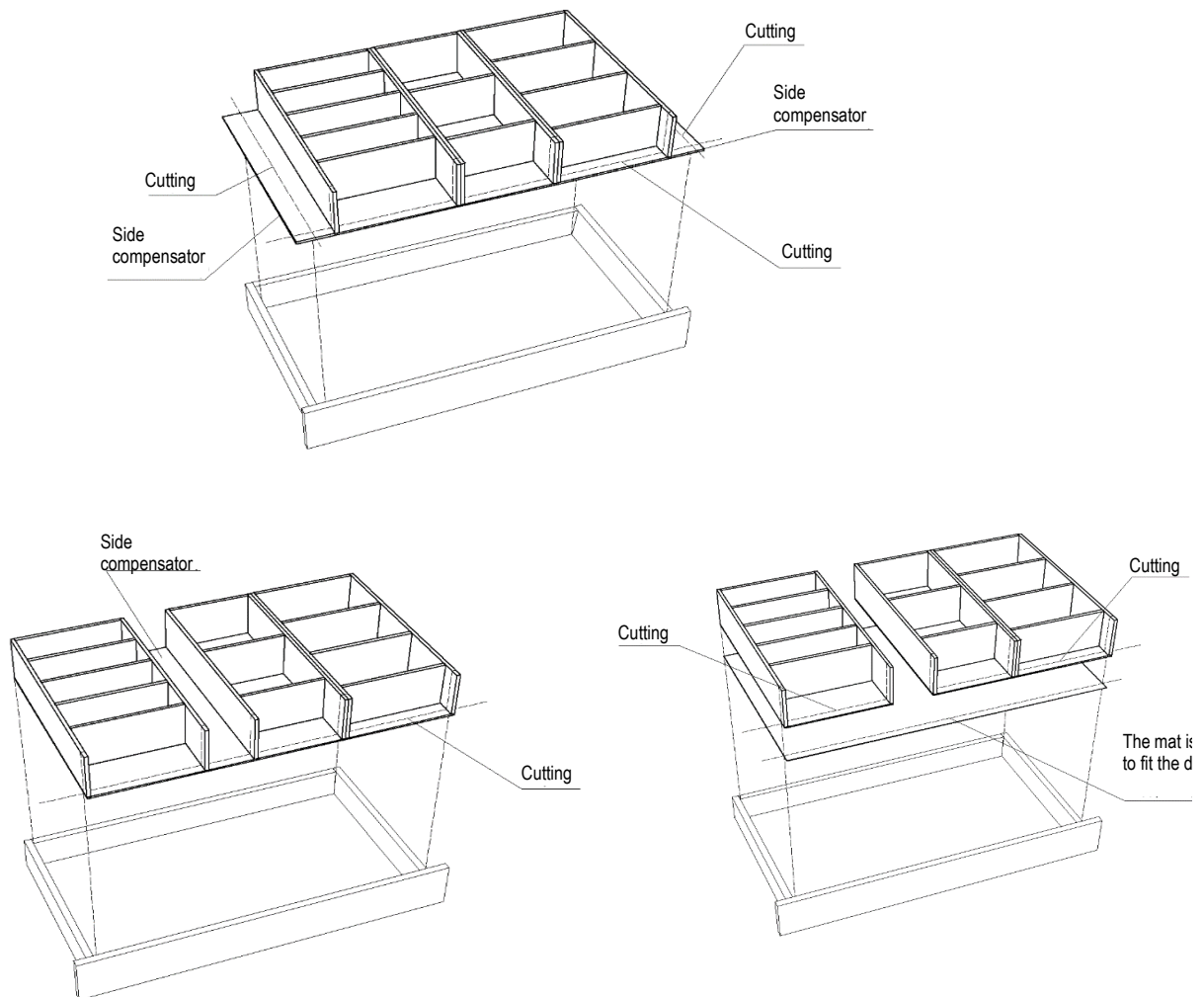

SERIES "BOXES"



BOXES are designed for organizing space anywhere.
BOXES are perfect for storing kitchen utensils, small items, tools, and small household appliances.
BOXES are also very convenient and useful for storing jewelry and other accessories.

Thanks to their special design, BOXES can be stacked on top of each other, forming several levels in height.

- BOXES are made from natural wood – solid ash.
- finish: a blend of natural plant oil and beeswax.
- The height of the BOXES: 55, 107, 159, and 211 mm.



TECHNICAL CATALOG-PRICE LIST
series "BOXES"



APPEARANCE & DESCRIPTION	CABINET WIDTH, mm	ORGANISER SIZE			ARTICLE CODE
		CABINET WIDTH, mm	HEIGHT, mm	LENGHT, mm	
<p>BOXES 55</p>  <p>The special design of the boxes allows them to be stacked on top of each other.</p>	-	55	150	200	KR55.150.200 Basic KR55.150.200 Color
	-	55	150	250	KR55.150.250 Basic KR55.150.250 Color
	-	55	150	300	KR55.150.300 Basic KR55.150.300 Color
	-	55	200	200	KR55.200.200 Basic KR55.200.200 Color
<p>BOXES 107</p>  <p>The special design of the boxes allows them to be stacked on top of each other.</p>	-	107	150	200	KR107.150.200 Basic KR107.150.200 Color
	-	107	150	250	KR107.150.250 Basic KR107.150.250 Color
	-	107	150	300	KR107.150.300 Basic KR107.150.300 Color
	-	107	200	200	KR107.200.200 Basic KR107.200.200 Color
<p>BOXES 159</p>  <p>The special design of the boxes allows them to be stacked on top of each other.</p>	-	159	150	150	KR159.150.150 Basic KR159.150.150 Color
	-	159	150	200	KR159.150.200 Basic KR159.150.200 Color
	-	159	150	250	KR159.150.250 Basic KR159.150.250 Color
	-	159	150	300	KR159.150.300 Basic KR159.150.300 Color
	-	159	200	200	KR159.200.200 Basic KR159.200.200 Color
	-	159	200	400	KR159.200.400 Basic KR159.200.400 Color
	-	159	250	400	KR159.250.400 Basic KR159.250.400 Color
	-	159	200	450	KR159.200.450 Basic KR159.200.450 Color
	-	159	250	450	KR159.250.450 Basic KR159.250.450 Color

TECHNICAL CATALOG-PRICE LIST
series "BOXES"



APPEARANCE & DESCRIPTION	CABINET WIDTH, mm	ORGANISER SIZE			ARTICLE CODE
		HEIGHT, mm	WIDHT, mm	LENGHT, mm	
<p>BOXES 211</p> 	-	211	150	200	KR211.150.200 Basic
	-	211	150	250	KR211.150.200 Color
	-	211	150	300	KR211.150.250 Basic
	-	211	150	300	KR211.150.250 Color
	-	211	200	200	KR211.150.300 Basic
	-	211	200	200	KR211.150.300 Color
	-	211	200	400	KR211.200.200 Basic
	-	211	200	400	KR211.200.200 Color
	-	211	250	400	KR211.200.400 Basic
-	211	250	400	KR211.200.400 Color	
-	211	200	450	KR211.250.400 Basic	
-	211	200	450	KR211.250.400 Color	
-	211	200	450	KR211.200.450 Basic	
-	211	200	450	KR211.200.450 Color	
-	211	250	450	KR211.250.450 Basic	
-	211	250	450	KR211.250.450 Color	
<p>LIDS</p> 	-	8	150	150	K8.150.150 Basic
	-	8	150	150	K8.150.150 Color
	-	8	150	200	K8.150.200 Basic
	-	8	150	200	K8.150.200 Color
-	8	150	250	K8.150.250 Basic	
-	8	150	250	K8.150.250 Color	
-	8	150	300	K8.150.300 Basic	
-	8	150	300	K8.150.300 Color	

SERIES "WOODEN DRAWERS"
(for the concealed sliding system for wooden drawers)



TECHNICAL CATALOG-PRICE LIST
series "WOODEN DRAWERS"

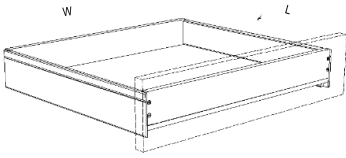
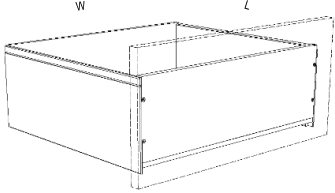
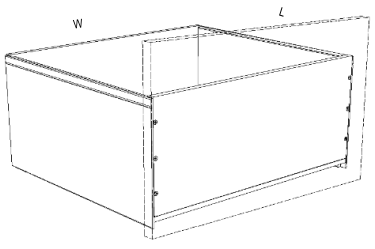

APPEARANCE & DESCRIPTION	CABINET WIDTH, mm	DRAWER			ARTICLE CODE
		HEIGHT, mm	WIDHT, mm	LENGHT, mm	
<p>WOODEN DRAWER, HEIGHT 90 mm</p> 	300	250	440	90	B.250.440.90
	400	350	440	90	B.350.440.90
	450	400	440	90	B.400.440.90
	500	450	440	90	B.450.440.90
	600	550	440	90	B.550.440.90
	700	650	440	90	B.650.440.90
	800	750	440	90	B.750.440.90
	900	850	440	90	B.850.440.90
	1000	950	440	90	B.950.440.90
	1100	1050	440	90	B.1050.440.90
	1200	1150	440	90	B.1150.440.90
	Drawer bottom: MDF, ash veneer on both sides				
<p>WOODEN DRAWER, HEIGHT 200 mm</p> 	300	250	440	200	B.250.440.200
	400	350	440	200	B.350.440.200
	450	400	440	200	B.400.440.200
	500	450	440	200	B.450.440.200
	600	550	440	200	B.550.440.200
	700	650	440	200	B.650.440.200
	800	750	440	200	B.750.440.200
	900	850	440	200	B.850.440.200
	1000	950	440	200	B.950.440.200
	1100	1050	440	200	B.1050.440.200
	1200	1150	440	200	B.1150.440.200
	Drawer bottom: MDF, ash veneer on both sides				
<p>WOODEN DRAWER, HEIGHT 250 mm</p> 	300	250	440	250	B.250.440.250
	400	350	440	250	B.350.440.250
	450	400	440	250	B.400.440.250
	500	450	440	250	B.450.440.250
	600	550	440	250	B.550.440.250
	700	650	440	250	B.650.440.250
	800	750	440	250	B.750.440.250
	900	850	440	250	B.850.440.250
	1000	950	440	250	B.950.440.250
	1100	1050	440	250	B.1050.440.250
	1200	1150	440	250	B.1150.440.250
	Drawer bottom: MDF, ash veneer on both sides				

TECHNICAL CATALOG-PRICE LIST
series "WOODEN DRAWERS"

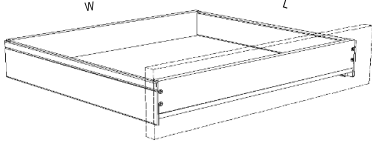
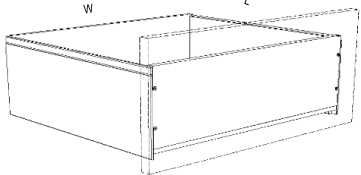
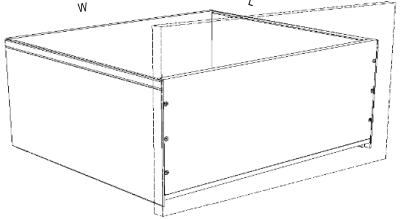

APPEARANCE & DESCRIPTION	CABINET WIDTH, mm	DRAWER			ARTICLE CODE
		HEIGHT, mm	WIDHT, mm	LENGHT, mm	
<p>WOODEN DRAWER, HEIGHT 90 mm</p> 	300	250	490	90	B.250.490.90
	400	350	490	90	B.350.490.90
	450	400	490	90	B.400.490.90
	500	450	490	90	B.450.490.90
	600	550	490	90	B.550.490.90
	700	650	490	90	B.650.490.90
	800	750	490	90	B.750.490.90
	900	850	490	90	B.850.490.90
	1000	950	490	90	B.950.490.90
	1100	1050	490	90	B.1050.490.90
	1200	1150	490	90	B.1150.490.90
	Drawer bottom: MDF, ash veneer on both sides				
<p>WOODEN DRAWER, HEIGHT 200 mm</p> 	300	250	490	200	B.250.490.200
	400	350	490	200	B.350.490.200
	450	400	490	200	B.400.490.200
	500	450	490	200	B.450.490.200
	600	550	490	200	B.550.490.200
	700	650	490	200	B.650.490.200
	800	750	490	200	B.750.490.200
	900	850	490	200	B.850.490.200
	1000	950	490	200	B.950.490.200
	1100	1050	490	200	B.1050.490.200
	1200	1150	490	200	B.1150.490.200
	Drawer bottom: MDF, ash veneer on both sides				
<p>WOODEN DRAWER, HEIGHT 250 mm</p> 	300	250	490	250	B.250.490.250
	400	350	490	250	B.350.490.250
	450	400	490	250	B.400.490.250
	500	450	490	250	B.450.490.250
	600	550	490	250	B.550.490.250
	700	650	490	250	B.650.490.250
	800	750	490	250	B.750.490.250
	900	850	490	250	B.850.490.250
	1000	950	490	250	B.950.490.250
	1100	1050	490	250	B.1050.490.250
	1200	1150	490	250	B.1150.490.250
	Drawer bottom: MDF, ash veneer on both sides				

TECHNICAL CATALOG-PRICE LIST
series "WOODEN DRAWERS"

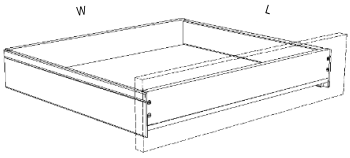
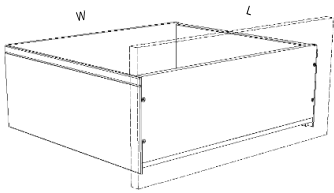
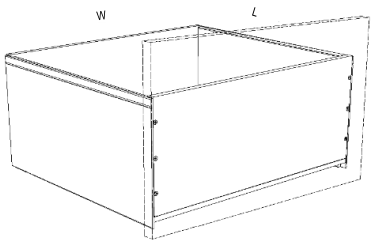

APPEARANCE & DESCRIPTION	CABINET WIDTH, mm	DRAWER			ARTICLE CODE
		HEIGHT, mm	WIDHT, mm	LENGHT, mm	
<p>WOODEN DRAWER, HEIGHT 90 mm</p>  <p>Drawer bottom: MDF, ash veneer on both sides</p>	300	250	540	90	B.250.540.90
	400	350	540	90	B.350.540.90
	450	400	540	90	B.400.540.90
	500	450	540	90	B.450.540.90
	600	550	540	90	B.550.540.90
	700	650	540	90	B.650.540.90
	800	750	540	90	B.750.540.90
	900	850	540	90	B.850.540.90
	1000	950	540	90	B.950.540.90
	1100	1050	540	90	B.1050.540.90
	1200	1150	540	90	B.1150.540.90
<p>WOODEN DRAWER, HEIGHT 200 mm</p>  <p>Drawer bottom: MDF, ash veneer on both sides</p>	300	250	540	200	B.250.540.200
	400	350	540	200	B.350.540.200
	450	400	540	200	B.400.540.200
	500	450	540	200	B.450.540.200
	600	550	540	200	B.550.540.200
	700	650	540	200	B.650.540.200
	800	750	540	200	B.750.540.200
	900	850	540	200	B.850.540.200
	1000	950	540	200	B.950.540.200
	1100	1050	540	200	B.1050.540.200
	1200	1150	540	200	B.1150.540.200
<p>WOODEN DRAWER, HEIGHT 250 mm</p>  <p>Drawer bottom: MDF, ash veneer on both sides</p>	300	250	540	250	B.250.540.250
	400	350	540	250	B.350.540.250
	450	400	540	250	B.400.540.250
	500	450	540	250	B.450.540.250
	600	550	540	250	B.550.540.250
	700	650	540	250	B.650.540.250
	800	750	540	250	B.750.540.250
	900	850	540	250	B.850.540.250
	1000	950	540	250	B.950.540.250
	1100	1050	540	250	B.1050.540.250
	1200	1150	540	250	B.1150.540.250

SERIES "ADDITIONAL ACCESSORIES"

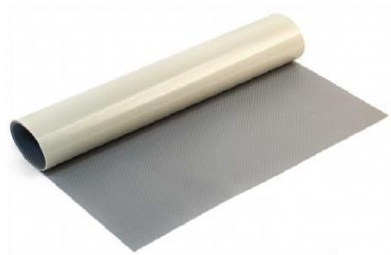



TECHNICAL CATALOG-PRICE LIST
series "ADDITIONAL ACCESSORIES"



APPEARANCE & DESCRIPTION	CABINET WIDTH, mm	ORGANISER SIZE			ARTICLE CODE
		HEIGHT, mm	WIDHT, mm	LENGHT, mm	
<p>RUBBER FURNITURE MAT</p>  <p>Mat thickness: 1.2 mm</p>		-	-	480	K.480
	Colors: WHITE, GRAY, ANTHRACITE, BROWN, BLACK				
		-	-	1450	K.1450
	Color: GRAY				
					Mat trimming to fit drawer size
<p>HAIRDRYER ORGANIZER</p> 	-	107	300	480	OF.107.300.480 Basic OF.107.300.480 Color Compensator trimming
<p>MIXTURE OF VEGETABLE OIL AND BEESWAX FOR WOOD TREATMENT</p> 			PET bottle, volume 30 ml		MR.30 Basic MR.30 Color

TECHNICAL CATALOG-PRICE LIST
series "ADDITIONAL ACCESSORIES"



APPEARANCE & DESCRIPTION	CABINET WIDTH, mm	ORGANISER SIZE			ARTICLE CODE
		HEIGHT, mm	WIDHT, mm	LENGHT, mm	
SIDE COMPENSATOR (solid wood) 	-	-	50	480	KB.50.480 Basic KB.50.480 Color
	-	-	100	480	KB.100.480 Basic KB.100.480 Color
	-	-	150	480	KB.150.480 Basic KB.150.480 Color
	-	-	200	480	KB.200.480 Basic KB.200.480 Color Compensator trimming
SIDE COMPENSATOR (solid wood) 	-	-	80	300	KZ.80.300 Basic KZ.80.300 Color
	-	-	80	500	KZ.80.500 Basic KZ.80.500 Color
	-	-	80	1000	KZ.80.1000 Basic KZ.80.1000 Color Compensator trimming

INSTRUCTIONS FOR MEASURING A FURNITURE DRAWER

Since different furniture companies use various drawer slide systems, the internal dimensions of drawers may vary.

The ERGOBOX company manufactures organizers in maximum sizes for drawers with **450 mm and 500 mm slide lengths**.

Trimming to match the actual drawer dimensions is required to properly place the organizer(s) in the drawer.

Figure 1 shows an example of placing a Classic Tray in a drawer with trimming of the side and rear compensators.

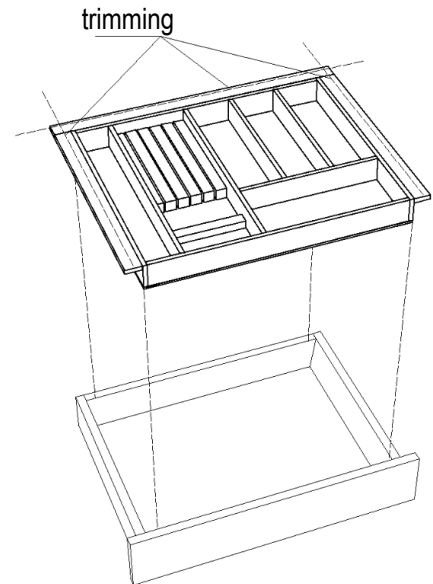

Figure 1

To ensure accuracy, measure the following three dimensions in millimeters:

Width (Figure 1): internal dimension from side to side at the bottom of the drawer (Fig. 2 or Fig. 3).

Length (L): internal dimension from the front panel to the back wall of the drawer (Fig. 4).

Height (H1) – height of the side panel inside the drawer. **Height (H2)** – height from the drawer bottom to the upper obstruction.

IMPORTANT! Please provide information on how the drawer is assembled and which slide system is used.

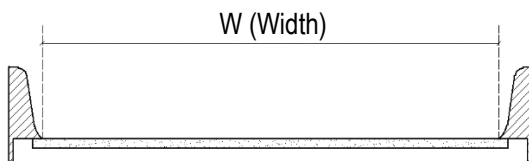

Figure 2

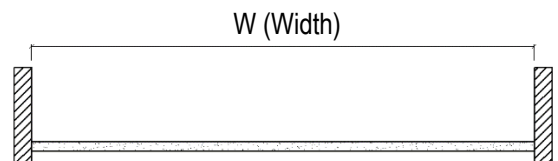

Figure 3

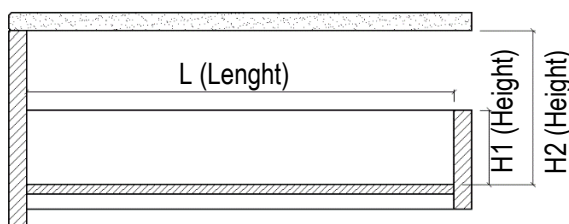

Figure 4

W = _____ mm
L = _____ mm
H1 = _____ mm
H2 = _____ mm

IMPORTANT! After trimming the organizer, the cut areas must be treated with a mixture of vegetable oils and wax.