

# PROFILI ANTINE DOOR PROFILES

SCILM PROPONE UNA VASTA OFFERTA DI PROFILI IN ALLUMINIO PER ANTINE, REALIZZATI SU MISURA PER QUALUNQUE DIMENSIONE DELLE ANTE.

È DISPONIBILE UN'AMPIA GAMMA DI FINITURE E PERSONALIZZAZIONI, TRA CUI: ANODIZZAZIONE, RIVESTIMENTO E VERNICIATURA. I PROFILI SONO DISPONIBILI CON GIUNZIONE A 45° CON SQUADRETTA OPPURE CON GIUNZIONE A 90°

Scilm offers a wide range of aluminum door profiles, with customized dimensions for every door size. The available finishing are: anodizing, coating and foiling. The profiles are available with 45° joint with joint plate, or 90°.



PROFILI ANTINE DOOR PROFILES



**PROFILI ANTINE** Door profiles

**GAMMA**  
RANGE

**ANTA DA 20,5 MM**  
DOOR W. 20,5 MM

**2449**

(vedi pag. 268)  
(see page 268)

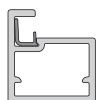

**2002**

(vedi pag. 271)  
(see page 271)

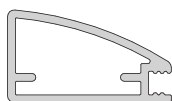

**2371**

(vedi pag. 275)  
(see page 275)

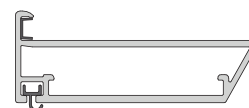

**2358**

(vedi pag. 268)  
(see page 268)

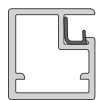

**2380**

(vedi pag. 272)  
(see page 272)

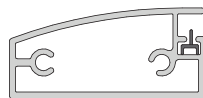

**2465**

(vedi pag. 275)  
(see page 275)



**2360**

(vedi pag. 269)  
(see page 269)

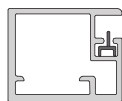

**2391**

(vedi pag. 272)  
(see page 272)

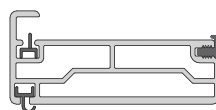

**2493**

(vedi pag. 276)  
(see page 276)

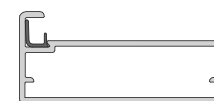

**2351**

(vedi pag. 269)  
(see page 269)

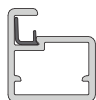

**2350**

(vedi pag. 273)  
(see page 273)

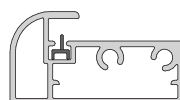

**2364**

(vedi pag. 276)  
(see page 276)



**2363**

(vedi pag. 270)  
(see page 270)



**2359**

(vedi pag. 273)  
(see page 273)

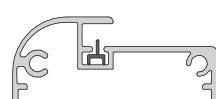

**2441**

(vedi pag. 277)  
(see page 277)

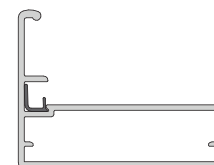

**2356**

(vedi pag. 270)  
(see page 270)



**2357**

(vedi pag. 274)  
(see page 274)

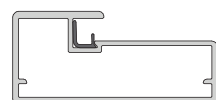

**2446**

(vedi pag. 277)  
(see page 277)



**2471**

(vedi pag. 271)  
(see page 271)

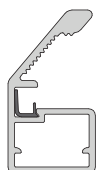

**2361**

(vedi pag. 274)  
(see page 274)

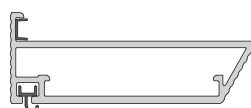

**2505**

(vedi pag. 278)  
(see page 278)



**PROFILI ANTINE** Door profiles

**GAMMA**  
RANGE

**ANTA DA 22 - 24 - 25 - 26 MM**  
DOOR W. 22 - 24 - 25 - 26 MM

**2472**

(vedi pag. 278)  
(see page 278)

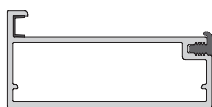

**2461**

(vedi pag. 281)  
(see page 281)

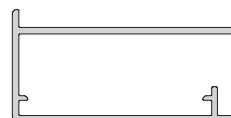

**2565**

(vedi pag. 279)  
(see page 279)

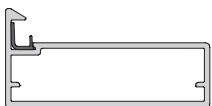

**2476**

(vedi pag. 283)  
(see page 283)



**2564**

(vedi pag. 279)  
(see page 279)

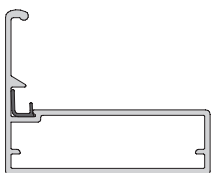

**2459**

(vedi pag. 282)  
(see page 282)

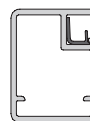

**2473**

(vedi pag. 280)  
(see page 280)



**2464**

(vedi pag. 282)  
(see page 282)

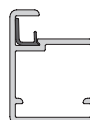

**2474**

(vedi pag. 280)  
(see page 280)

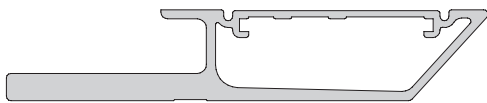

**2556**

(vedi pag. 262)  
(see page 262)

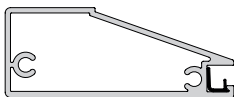

**2460**

(vedi pag. 281)  
(see page 281)



**PROFILI ANTINE** Door profiles

# **CALCOLO DIMENSIONAMENTO VETRI CONSIGLIATO**

DIMENSIONING CALCULATION FOR  
GLASS PANELS RECOMMENDED

**ANTE GIUNZIONE 90° - ART. 2556**

90° DOOR FIXING PLATES

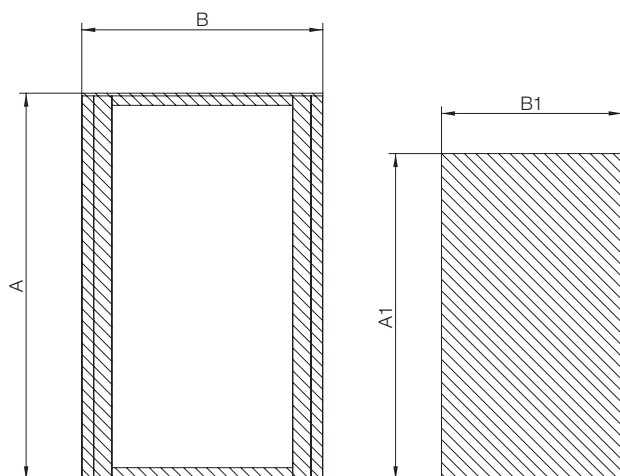

$$B1 = B - 102$$
$$A1 = A - 13$$

**ANTE GIUNZIONE 45° - ART. 2556**

45° DOOR FIXING PLATES

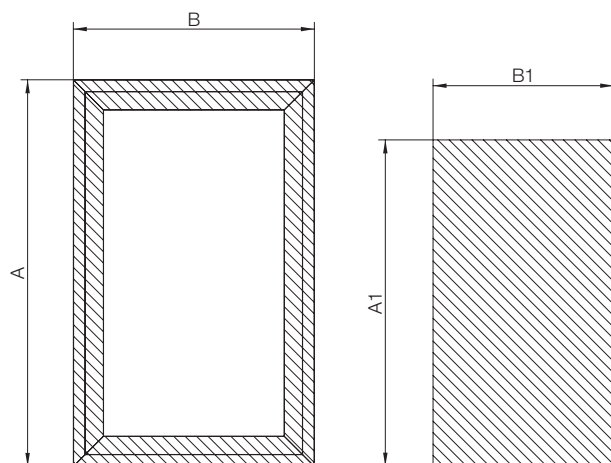

$$B1 = B - 102$$
$$A1 = A - 102$$

## PROFILI ANTE Door profiles

### Anta 2556 taglio 90° maniglia 2558 Door 2556 90° edge handle 2558

Vite per giunzione a 90°.  
Screw for 90° joint.

Possibilità di personalizzare: la misura dell'anta  
Optional custom-sizing: door dimensions

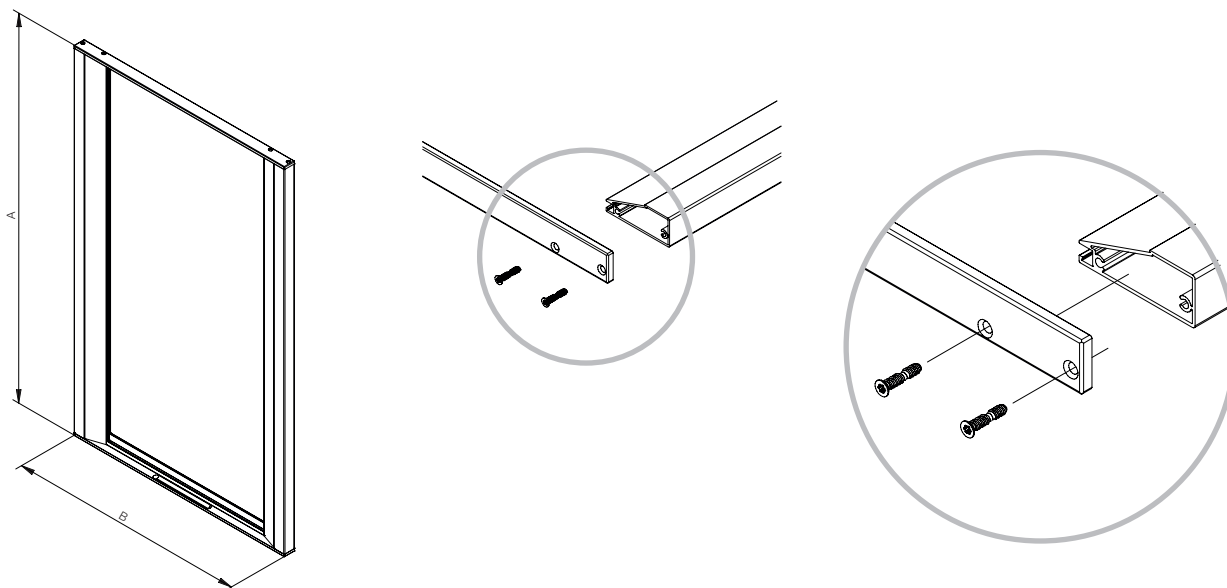

### Anta 2556 taglio 90° maniglia 2557 Door 2556 90° edge handle 2557

Possibilità di personalizzare: la misura dell'anta e la posizione della maniglia  
Optional custom-sizing: door dimensions and handle position

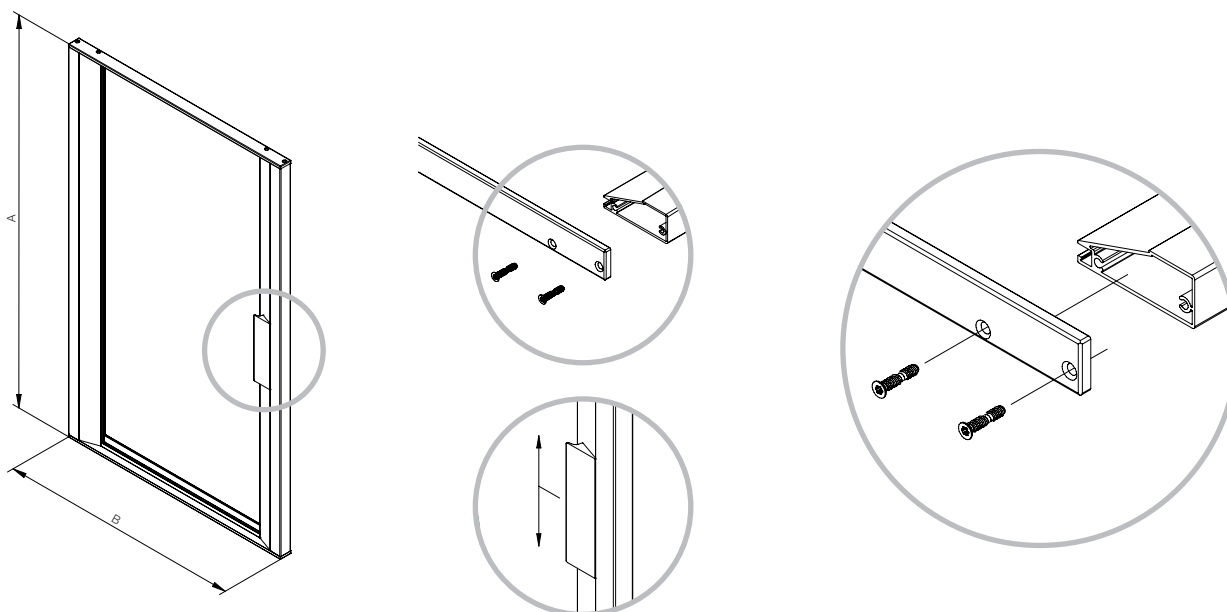

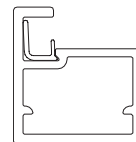

## PROFILI ANTE Door profiles

### 2556

Profilo anta.  
Door profile.

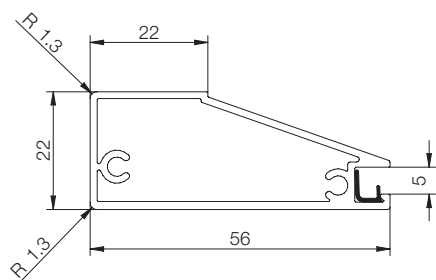

Code	L.	min. order qty (nr)	pcs/box (nr)	Kg.
------	----	---------------------	--------------	-----

R2556xxxL41	4100	10		26
-------------	------	----	--	----

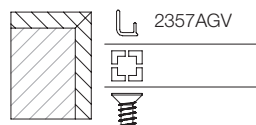

### 2558XXX.XXXX

Traverso 90° con maniglia.  
90° crossbar with handle.

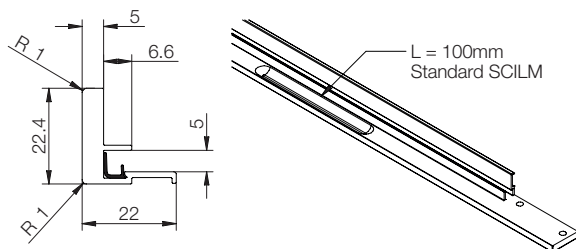

Code	unit	min. order qty (nr)	pcs/box (nr)	Kg.
------	------	---------------------	--------------	-----

2558xxx.xxxx	NR	36	36	-
--------------	----	----	----	---

2558xxx.xxxx	NR	36	36	-
--------------	----	----	----	---

### 2558XXX.XXXX

Traverso 90° per anta 2556.  
90° crossbar for door 2556.

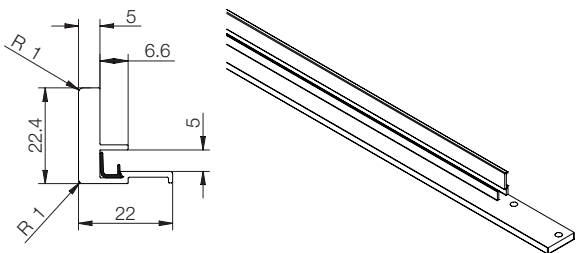

Code	unit	min. order qty (nr)	pcs/box (nr)	Kg.
------	------	---------------------	--------------	-----

2558xxx.xxxx	NR	36	36	-
--------------	----	----	----	---



## PROFILI ANTE Door profiles

### 2557XXX.XXX2

Maniglia per anta 2556.  
Handle for door 2556.

Code	unit	min. order qty (nr)	pcs/box (nr)	Kg.
2557xxx.0002	NR	50	50	-

Viti da utilizzare: M4x20 testa svasata piana.

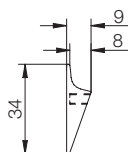
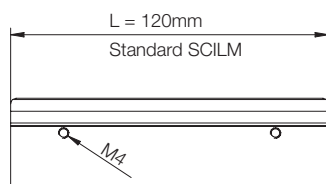
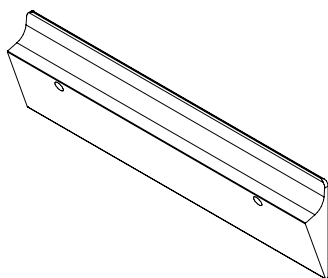

### VS39X18X

Vite speciale per traversi 90° art.2558.  
Special screw for 90° crossbars item 2558.

Code	unit	min. order qty (nr)	pcs/box (nr)	Kg.
VS39X18x	NR	400	400	-

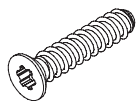
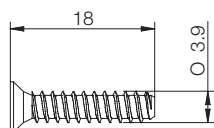

Legenda  
N - nichelata  
B - zincata nera

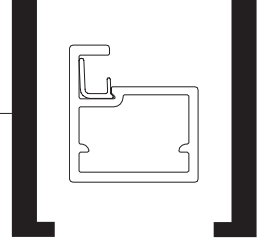

## PROFILI ANTE Door profiles

Anta 2556 taglio 45° maniglia 2557  
Door 2556 45° edge handle 2557

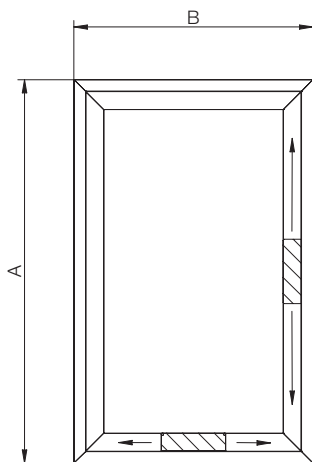
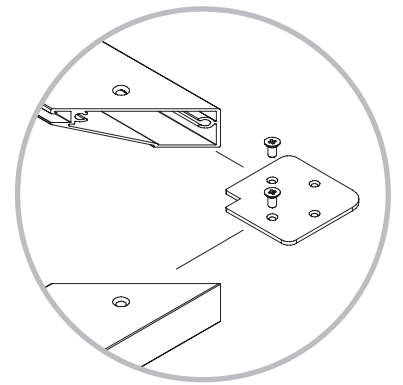
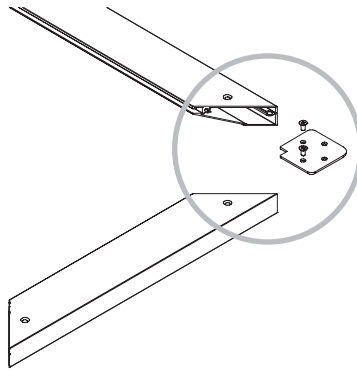
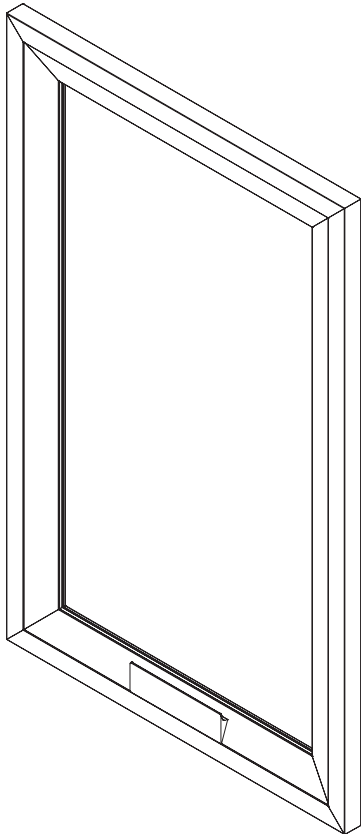

Possibilità di personalizzare: la misura dell'anta e la posizione della maniglia  
Optional custom-sizing: door dimensions and handle position

**PROFILI ANTE** Door profiles

**2556**

Profilo anta.  
Door profile.

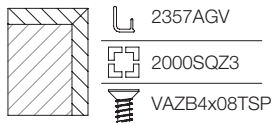
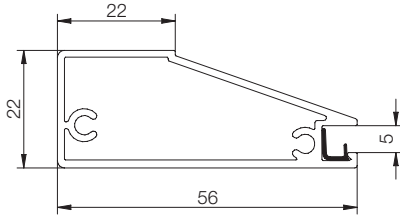

L = 120mm / 150mm

Code	unit	min. order qty (nr)	pcs/box (nr)	Kg.
R2556xxxL41	4100	10	10	26

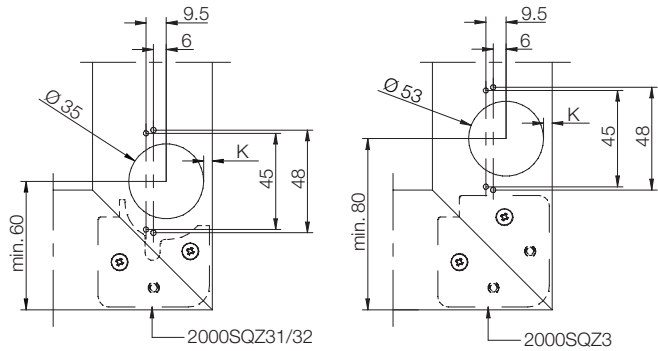

**2557XXX.XXX2**

Maniglia per anta 2556.  
Handle for door 2556.

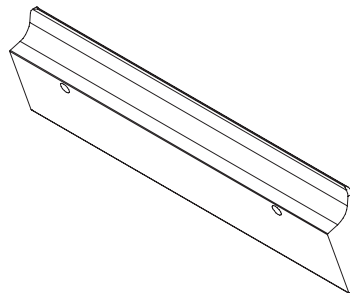
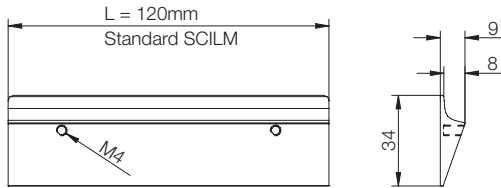

Code	unit	min. order qty (nr)	pcs/box (nr)	Kg.
2557xxx.xxx2	NR	50	50	-